

LOOKINGPLAS

www.lookingplas.com

SEPTEMBER 2016

B2B Platform Focus on Plastic Machinery

 **JIECHENG**

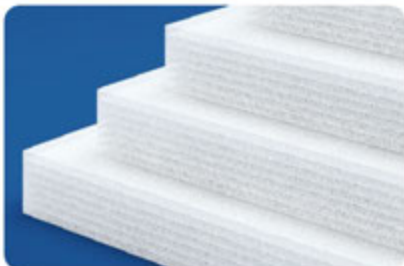

Manufacturer of Plastic Foam Machinery

Chongqing Bishan Jiecheng Plastic Co., Ltd, China

[Http://www.cqjiecheng.com](http://www.cqjiecheng.com)

E-mail: sales@cqjiecheng.com

Office Line: 0086-23-41781538



B2B Platform Focus on Plastic Machinery

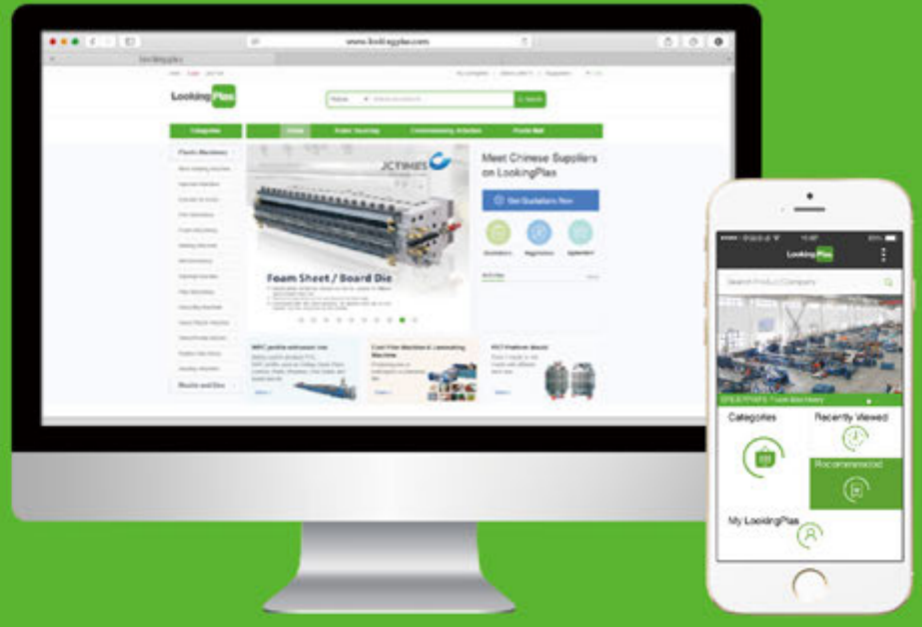

<http://www.lookingplas.com>



LookingPlas in Global



Chinaplas



Thailand



Indonesia



Vietnam



Bangladesh



India



Iran



Egypt



Turkey



South Africa



Russia



Italy

CONTENTS

15 SPOTLIGHT



24 SPOTLIGHT



39 SPOTLIGHT



More Chinese Suppliers?

1 Enter Website

[Http://www.lookingplas.com](http://www.lookingplas.com)

2 Download LookingPlas Mobile APP

Available on
App Store

or

Available on
Google play



Scan QR Code

3 LookingPlas Magazines

Blow Molding Machine

- 01 YANTAI FANGDA ROTATIONAL MOLDING CO., LTD.
- 02 LIUZHOU JINGYE MACHINERY CO., LTD.

Injection Machine

- 03 SHANDONG SENVO PRECISION MACHINERY CO., LTD.
- 04 HUIZHOU YANG XIN PLASTIC MACHINE CO., LTD.

Extruder & Screw

- 05 ZHOUSHAN BATTEN MACHINERY TECHNOLOGY CO., LTD.
- 06 NANJING ZHUO-YUE EXTRUDERS CO., LTD.

Film & Packing Machinery

- 07 HANGHAI BEI YANG PLASTIC MACHINERY TECHNOLOGY CO., LTD.
- 08 RUIAN CITY LIJIA MACHINERY CO., LTD.
- 09 LANGFANG ZHONGFENG MECHANICAL TECHNOLOGY CO., LTD.
- 11 SUZHOU NEWLINE MACHINERY CO., LTD.
- 12 JIANGSU LAIYI PACKING MACHINERY CO., LTD.

Foam Machinery

- 13 LONGKOU TIANHAI PRECISION MACHINERY CO., LTD.
- 14 CHONGQING BISHAN JIECHENG PLASTIC CO., LTD.

Knitting Machine

- 15 WENZHOU LIFEI MACHINERY CO., LTD.
- 16 WENZHOU QIANFENG TECHNOLOGY CO., LTD.

PANEL/PIPE/PROFILE EXTRUSION EQUIPMENT

- 17 QINGDAO XINQUAN PLASTIC MACHINERY CO., LTD.
- 18 ZHANGJIAGANG SUNRISE MACHINERY CO., LTD.
- 19 QINGDAO ZHENXIONG MECHANICAL EQUIPMENT CO., LTD.
- 20 ZHANGJIAGANG LANGBO MACHINERY CO., LTD.
- 21 SHANTOU SHIXIANG MACHINERY CO., LTD.
- 22 DONGGUAN LIMA MACHINERY MANUFACTURING CO., LTD.
- 23 QINGDAO POWERTECH MACHINERY CO., LTD.
- 24 JIAXING JUNSHENG MACHINERY CO., LTD.
- 25 NINGBO KONRUN MACHINERY TECHNOLOGY CO., LTD.
- 26 ZHANGJIAGANG ABLEPLAS MACHINERY CO., LTD.
- 27 BEIER MACHINERY GROUP
- 28 ZHANGJIAGANG FRIEND MACHINERY CO., LTD.

Recycling/Granulator Machine

- 29 NINGBO HOPESUN MACHINE CO., LTD.
- 30 ZHANGJIAGANG S&K MACHINERY CO., LTD.

Ancillary Equipment

- 31 SHIJIAZHUANG ZHONGSHI TESTING MACHINE CO., LTD.
- 32 ZHE JIANG SYNEMOT ELECTRICAL TECHNOLOGY CO., LTD.

Mould & Dies

- 33 TAIZHOU CITY HUANGYAN LUYA MOULD FACTORY
- 34 TAIZHOU HUANGYAN DINGXIANG MOUD PLASTIC CO., LTD.
- 35 ZHEJIANG GANGNAM MOULD CO., LTD.
- 36 ZHEJIANG HUANGYAN HONGQI PLASTIC MOULD FACTORY
- 37 ZHEJIANG TAIZHOU HUANGYAN CHUANGYUAN MOULD FACTORY

RAW MATERIALS & AUXILIARIES

- 38 LIAONING JINGHUA NEW MATERIAL INC.
- 39 WUXI CITY JIASHENG HIGH-TECH MODIFIED MATERIAL CO., LTD.
- 40 SHANDONG YUHONG NEW PIGMENT CO., LTD.

Plastic Product

- 41 SHANDONG TERRY SUPPLY CHAIN MANAGEMENT CO., LTD.

LookingPlas Magazines

Distribute to all the buyers for free in well-known plastic industry exhibitions.



• Without clear written permission of the copyright from the contributor, anyone can't copy or reprint whole or part of the magazine content by any means. The contributor is in charge of the contents and intellectual property of the manuscript. LookingPlas Group reserves the right of final explanation.



转塔独立式滚塑机
Carousel Rotomolding Machine



穿梭机
Shuttle Rotomolding Machine



磨粉机
Pulverizer Machine

**FOCUS ON FULL-AUTOMATIC
SINGLE-STAGE IBM & ISBM TECHNOLOGY FOR 18 YEARS**

SUPERB BLOW MOLDING TECHNOLOGY EXPLORER



More models for :

- 1) Sports bottle from ---PC/PP/Tritan
- 2) Yogurt & Pharmaceutical packing from---PET/HDPE/PS;
- 3) Baby feeder from---PP/PPSU/PC ;
- 4) LED Bulb from ---PC/PMMA;
- 5) Cosmetic packing from---PP/HDPE/PETG.



Obtained 4 invention patents, 12 utility model patents.
With full support from senior expert who enjoy the national special allowance.

JINGYE MACHINERY CO.,LTD.

TEL: (86)0772-3269199

Email: jingyeco@jingyeco.com

Address: Xinxing Industrial park,Liuzhou,Guangxi,China

FAX: (86)0772-7508981

Website: www.jingyeco.com

烟台方大滚塑有限公司

Yantai Fangda Rotational Molding Co., Ltd.

地址(Add): 山东省烟台市高新区创新路21号 (264670)

No.21 Chuangxin Road, Hi-tech Zone, Yantai, Shandong Province, China 264670

电话(Tel): 086-535-6766575

传真(Fax): 086-535-6766676

邮箱(E-mail): fd@fangdaroto.com

网址(Web): www.fangdaroto.cn



伺服节能注塑机

SERVO INJECTION MOLDING MACHINE

ZS60-ZS2200

- 快速 **Speedy**
- 省电 **Power-saving**
- 可靠 **Reliable**
- 低噪音 **Low noise**



地 址：山东省莱芜高新区盘龙大街 15 号
 市场部：+86-0634-8860668
 传 真：+86-0634-8860266
 邮 箱：sales@sdsenvo.com
 网 址：www.sdsenvo.com

Add: NO.15 Panlong Street, High-tech Zone,
 Laiwu, Shandong, China
 T e l : +86-0634-8860668
 F a x : +86-0634-8860266
 E-mail : sales@sdsenvo.com
 http: www.sdsenvo.com

山东胜岳精密机械有限公司
 SHANDONG SENVO PRECISION MACHINERY CO.,LTD



Energy-Saving Servo Injection Molding Machine

60Ton~850Ton YS YF Series
 Clamping Force 60Ton~3700Ton
 1000Ton~3700Ton Two-Platen YT Series
 230Ton~1420Ton Two- color YC Series



Website: <http://www.hzyangxin.com>
 E-mail: hzyangxin@126.com

TEL : +86-752-6833832
 FAX : +86-752-6833822



舟山巴顿机械科技有限公司

Zhoushan Batten Machinery Technology Co.,Ltd

www.batten-machinery.com

sales@batten-machinery.com



Mobile/Whatsapp

+86 186 5804 0272/186 0580 0326

+86 159 5807 0870/137 3502 5253



NanJing Zhuo-Yue extruder equipment Co.Ltd the pioneer in compounding manufacture system filed is concentrated on research and manufacture of twin screw compounding extruder system and provides the best solution in the most of application field.

HTE Series of High Torque Twin Screw Compounding Extruder

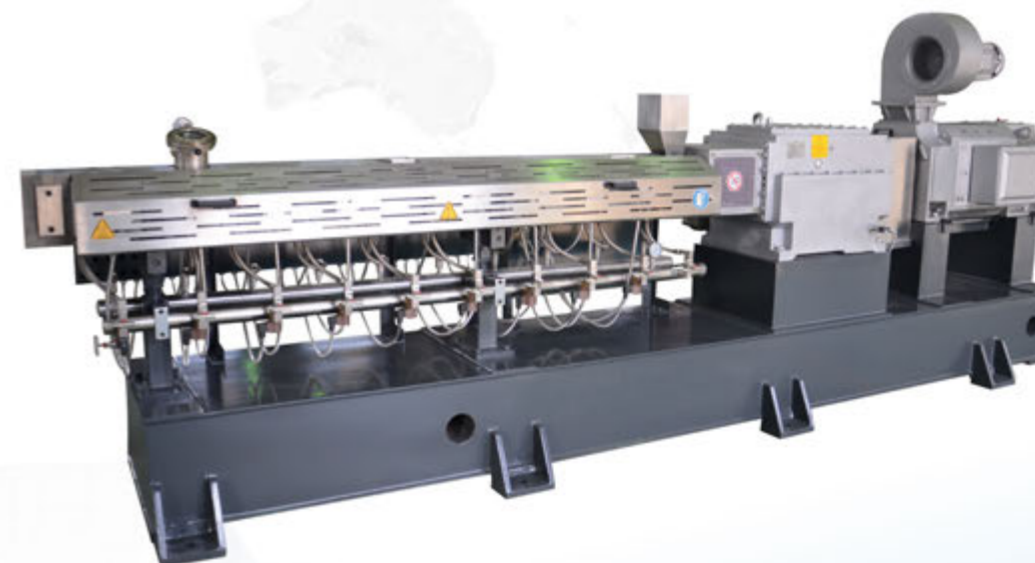

Perfect Combination Of High Performance and Quality Cooperation to Achieve Excellence



NANJIGN ZHUO-YUE EXTRUDERS CO., LTD

E-mail: lxl@zyextruders.com

FAX : +86-25-5270 0564

Website: http://www.zyextruders.com

Shanghai Bei Yang
Plastic Machinery Technology Co., Ltd.



Professional Manufacturer for
PVC Heat Shrinkable Film Blowing Machine
Printing Film Blowing Machine



Column Type PVC Heat Shrinkable Film Blowing Machine
Application: printing film, packaging film, aluminum film



Upper Lifts PVC Heat Shrinkable Printing Film Blowing Machine
Application: printing film, packaging film



Water Bath PVC Heat Shrinkable Film Horizontal Blowing Machine
Application: packaging film. Used in electrical appliances, electronic components, battery casing, skin care products, cosmetics and so on outer packing



Gun Barrel PVC Heat Shrinkable Film Horizontal Blowing Machine
Application: electronic components packing, battery sleeve, swob handle sleeve and so on tightly packing.



Upper Rotation PVC Heat Shrinkable Film Blowing Machine
Application: printing film, packaging film



Aluminum PVC Heat Shrinkable Film Upward Blowing Machine
Application: aluminum film

瑞安市立佳机械有限公司
**Ruian City Lijia
Machinery Co., Ltd.**



EPE发泡膜(珍珠棉)打孔切片机
EPE Foam Film Perforate Slitting Machine



LJ-900TD-高速套袋机
High Speed Non-woven Bag Making Machine



LJQD-1500/2500型
聚乙烯复合气垫(泡)膜机组
PE Compound Air Cushion(Air Bubble)
Film Extrusion Machine



LJDKJ-1200/1600/2000型
地膜自动打孔机
Film Automatic Punching Machine

Shanghai Bei Yang Plastic Machinery Technology Co., Ltd.

Mobile phone/Whatsapp/WeChat: +86-15601800787(Linda)

Fax: +86-021-67727128 Ext 0 Tel: +86-021-67727128 Ext 13 E-mail: 2631493675@qq.com

Web: www.beiyangsj.com http://shop1379523802548.1688.com http://shbeiyang.en.alibaba.com

CONTACT US

• 地址: 浙江省瑞安市飞云镇飞云东路18号

Add: No.18 Feiyun east road, Feiyun town, Ruian city, Zhejiang Province

• 手机: +86-13396778828

• 电话: +86-577-65020333

• 联系人: 谢先生

Mob: +86-13396778828

Tel: +86-577-65020333

Contact: Mr Xie



Single Line Auto-Punching T-shirt Bag Making Machine

Model No.: SFHP-550; SFHP-650; SFHP-1000

- Equipped PLC Program With Touch Screen
- Servo Motor Accurately Controls Feeding Speed
- Specialized Unwinding Device Without Stretching
- Hot Cutter Heats Independently Separated With Hot Sealer
- Full-Automatic Circulatory Lubricate System Serves For Principal Anxis



Double Line Auto-Punching T-shirt Bag Making Machine

Model No.: DFHP-300x2; DFHP-320x2; DFHP-420x2; DFHP-500x2

- Equipped PLC Program With Touch Screen
- Servo Motor Accurately Controls Feeding Speed
- Specialized Unwinding Device Without Stretching
- Hot Cutter Heats Independently Separated With Hot Sealer
- Full-Automatic Circulatory Lubricate System Serves For Principal Anxis

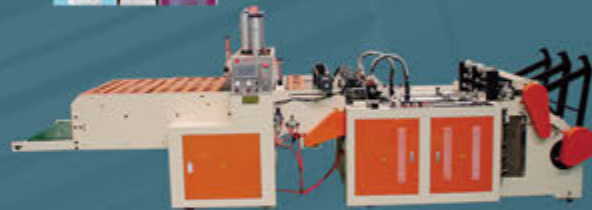

Single Screw Series Film Blowing Machine

Model No.: LF-S55; LF-S60; LF-S65

- Suitable Materials: LDPE/HDPE/LLDPE
- CNC Plastic Extrusion Control System
- Single Screw Diameter(mm): 55; 60; 65
- Film Thickness(mm): 0.01-0.10

Double Screw ABA Series Film Blowing Machine

Model No.: LF-ABA55; LF-ABA60; LF-ABA65

- Suitable Materials: LDPE/HDPE/LLDPE
- Three Layer Layers Co-extrusion
- Double Screw Diameter(mm): 55x2; 60x2; 65x2
- Film Thickness(mm): 0.01-0.10



Single Line Bottom Seal Flat Bag Making Machine

Model No.: SFB-1100; SFB-1200

- Equipped PLC Program With Touch Screen
- Servo Motor Accurately Controls Feeding Speed
- Specialized Unwinding Device Without Stretching
- Cold Cutting And Hot Sealing Works Synchronously
- Automatic Robot Hand Stack And Fold Bags Smoothly



Single Line Tipping Type Bag Making Machine

Model No.: SFT-550; SFT-650; SFT-1000

Double Line Tipping Type Bag Making Machine

Model No.: DT-300x2; DT-350x2; DT-450x2



Full-Automatic Core Bag-On-Roll Making Machine

Model No.: DFR-450x2; SFR-600

- Equipped PLC Program With Touch Screen
- Servo Motor Accurately Controls Feeding Speed
- Specialized Unwinding Device Without Stretching
- Point Cutting And Hot Sealing Work Synchronously
- Automatic Winding Device Improved Productivity



Double Line Four Rolls Feeding Cold Cutting Hot Sealing Auto-Punching Bag Making Machine

Model No.:4DCP-300x4



NEWLINE MACHINERY

Suzhou Newline Machinery Co., Ltd., invested by Jiangsu Guotai Int'l Group, is a high-tech enterprise that has absorb the foreign advanced technology and experience, in strict accordance with the national GMP requirements of working for research, design, manufacture and sales in medicine and food packaging machinery.

We specialize in viscous liquid filling/capping 2in1 machines, water/juice washing/filling/capping 3in1 machines & water treatment. We can also develop and design to conform to your needs.

We offer the best cost-effective and quality equipments.

With years of effort, our products have been exported to Asia and Africa.

WASHING/DRYING MACHINE



Rotary Volumetric Filling/Capping Machine is widely used in Pharmaceutical Industries, such machine can also used for Food, Oil, Chemicals & other Viscous Liquid or Syrup filling applications.

The filling Principal is Volumetric.

TECHNICAL SPECIFICATION

MODEL	Filling heads	Capping heads	Dimensions (in mm) (L x W x H)	OUTPUT (BPM on 60ml bottles)
NLMSM8-4	8	4	2000x1400x2000	50
NLMSM12-6	12	6	2000x1400x2000	70
NLMSM16-6	16	6	1900x1600x2000	100
NLMSM24-8	24	8	2400x1900x2000	150
NLMSM32-10	32	10	3000x2300x2000	200

WASHING/FILLING/CAPPING MACHINE



The machine is a full automatic 3in1 washing-filling-capping unit, widely used for all kinds of no gas, no viscous liquid, such as Juice, Oil, Vinegar, wine, mineral water & pure water.

TECHNICAL SPECIFICATION

MODEL	Washing/ Filling/Capping heads	Motor power (kw)	Dimensions (in mm) (L x W x H)	OUTPUT (BPH on 500ml bottles)
NLMW16-12-6	16-12-6	2.2	2400x1650x2000	3500
NLMW18-18-6	18-18-6	3.0	2600x1920x2000	7000
NLMW24-24-8	24-24-8	3.5	3100x2300x2000	12000
NLMW32-32-10	32-32-10	5.5	3800x2800x2000	15000
NLMW40-40-10	40-40-10	7.0	4600x2800x2300	18000
NLMW50-50-15	50-50-15	10.0	5400x3300x2500	22000

LY-ASCP型彩印包装共挤挤出复合机

CO-EXTRUSION COATING LAMINATING MACHINE

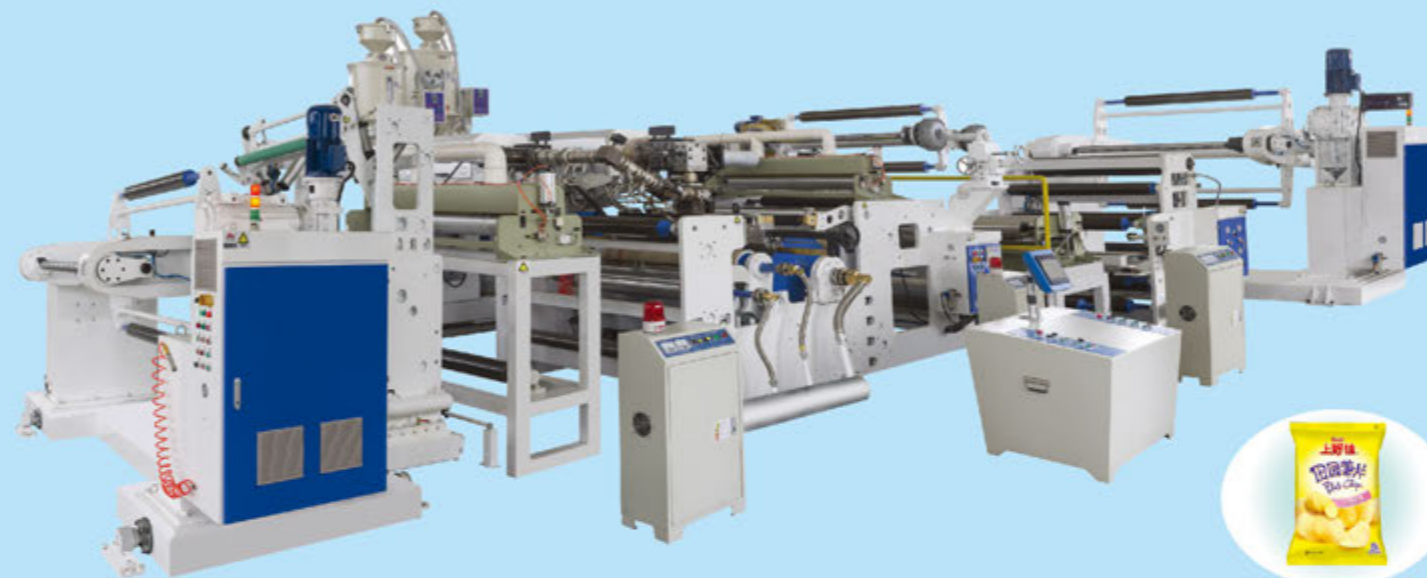

LY-Y预涂膜专用挤出复合机

BOPP Laminating Film Extrusion Lamination Machine



Add: 238 East Jinsheng Road, Jintan Area, Changzhou City, Jiangsu Prov., China

Tel: 0086-519-83138969 Fax: 0086-519-83434811 Mob: 0086-13651507296

Contact: Liu Laiyi

Web: www.laiyitrusion.com





天海

Tianhai Precision Machinery

LONGKOU TIANHAI PRECISION MACHINERY CO. LTD

CE ISO9001

JIECHENG

THE BIGGEST MANUFACTURER OF PLASTIC FOAM MACHINERY IN THE WORLD

EPS foam cup making machine



Vacuum forming machine



PS foam sheet extrusion line



YOUR SATISFACTION IS OUR BIGGEST TARGET

Longkou Tianhai Precision Machinery Co. Ltd is one of the best professional manufacturers for PS foam fast food box (one time dishes) production line and plastic package machinery. With strong technical strength and more than 15 years experiences, our machines have already been exported to more than 30 countries and areas.

- PS fast food box production lines
- Vacuum forming machine
- EPE foam sheet production line
- PS foam sheet extrusion line
- KT board line
- Plastic laminating machine
- Hydraulic Cutting Machine
- XPS foam board extruding line
- Recycling granulators



Add: Qiwei Road, Huangcheng Industrial Park, Longkou, Shandong, China
Tel/Fax: 0086-535-8610056/8610055 whatsapp: +8613562504605 Wechat: zHy19970501
Web: www.yttianhai.com E-mail: sales@yttianhai.com

Chongqing Bishan Jiecheng Plastic Co., Ltd

Http://www.cqjiecheng.com E-mail: sales@cqjiecheng.com Office Line: 0086-23-41781538

WENZHOU LIFEI MACHINERY CO., LTD.

- WENZHOU LIFEI MACHINERY CO., LTD is a professional manufacturer for woven bag complete set, PP woven bag production line and package machines.
- Our company with all our staffs sincerely hope to have a pleasure cooperation with customers both at home and abroad in the future.



The machine is suitable for flat yarn of polypropylene (PP), high density polyethylene (HDPE) as raw materials which produce high efficiency cloth of woven bag.



Our company manufactured a round mesh plastic circular loom can be used as a warp yarn and woven flat weave mesh Bag, by cutting, sewing bag packaging to produced bag packaging of vegetables, fruits etc.



温州立飞塑料机械厂
WENZHOU LIFEI MACHINERY CO., LTD.

Plastic tape drawing machine

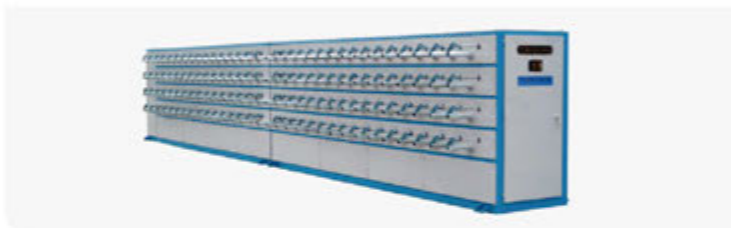

Cam type winding machine



This yarn making machine is absorbed from international advanced technical and manufactures by ourselves, which major in producing yarn by HDPE, PP material, PET, Nylon etc.

Address: Aojiang Avenue, Aojiang Town, Pingyang County, Wenzhou City, Zhejiang Province, China
Contact Person: Caroline
Phone Number: +86-13587995528
Viber: +86-13587995528 **WeChat:** +86-13587995528
WhatsApp: +86-13587995528(Lifei machinery)
Skype: timeless_caroline **E-mail:** 369931139@qq.com

About Us

Qianfen international Co., Ltd. is plastic machinery manufacturer with scientific research, development, manufacture, sales and service.

It is well-known and more than 10 years rich experiences, to supply the suitable plastic machinery to all of our clients is our biggest goal!

Our main productions are PP woven bag machinery, such as tape drawing, winding, loom, printing machine, cutting and sewing machine, PP nonwoven fabric making machine, PE film soft bag machinery, packing machine.



Flexographic printing machine



Six-shuttle loom



Auto. cutting machine



Flexographic printing machine for PP woven sack



Film blowing machine



Auto cutting and sewing machine

Add: C37, Economic Development Zone, Pingyang, Wenzhou, Zhejiang, China
 Ms Candy (General Manager)
 E-mail: qianfenco@foxmail.com
 Tel: +0086 - 13868589622/ 18167288781
 Fax: +0086 - 577 - 63682893



青島鑫泉塑料機械有限公司
Qingdao Xinqun Plastic Machinery Co., Ltd



Stand No:
A2-Y15 (Sept. Tth 10th 2016)



SUNRISE MACHINERY

CE ISO9001:2003

ZHANGJIAGANG SUNRISE MACHINERY CO., LTD.

PP, PC Hollow Profile Sheet Production Line

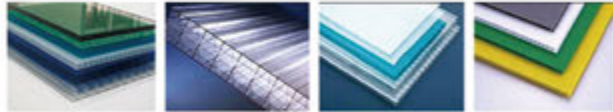

PVC PIPE PRODUCTION LINE



PE,PP,PS,PC,PMMA,PET Single or Multi-layer Sheet Co-extrusion Line



LARGE DIAMETER PE PIPE PRODUCTION LINE



PVC HIGH SPEED MIXER

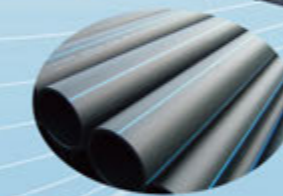

PP-R,PP,PE,PE-RT Single-layer or Multi-layer Pipe Production Line



PE, PP, PVC Wood Composite (WPC) Board/Profile Production Line
PP, PC Hollow Grid Board Production Line
PE, PP, PS, ABS, PC, PMMA Board/Sheet Production Line
PVC Foamed/Skinning Foamed/WPC Foamed Board Production Line

HDPE, LDPE, PP-R, PE-RT Water/Gas Supply Pipe Production Line
PVC, PE Single and Double Wall Corrugated Pipe Production Line
U-PVC Water Supply and Drainage Pipe Production Line
PP, PET Strapping Band Production Line



Add: Wuzhou Road, Jiaozhou, Qingdao City, Shandong, P.R. China
Tel: +86-532-82212931 Fax: +86-532-8222038
Mobile: +86-13606307602 Website: http://www.qdxinqun.com
E-mail: xq8@qdxinqun.com(Chinese) xq9@qdxinqun.com(English)



Tel: 0086-13962204199 Fax: 0086-512-58361860
Email: info@zjgsunrise.com Website: www.zjgsunrise.com
Add: No. 99 Lefeng Road, Leyu Town, Zhangjiagang City, Jiangsu Province, China



Products list:

- Automatic Refrigerator Door Gasket Production Line
- Large Diameter Pipe Equipment
- Plastic Grass Production Equipment
- WPC/PVC Profile Machine Series
- Plastic Mat Equipment
- Flex Banner Cloth Production Line
- Single / Multi-layer Plastic Sheet / Plate Production line
- PVC Imitation Marble Wall Panel Machinery

• Pipe Extruding Head

• High Efficiency Single-screw Extruder

• Large Diameter Drain Pipe Production Line



- Diameter range 300-3000mm
- Light weight per meter
- Simple connection
- Reliable and good sealing

• Automatic Refrigerator Door Gasket Production Line



This production line integrates PLC control system, auto 45 degree cutting machine, auto puncher, mechanical hands and auto gasket welding machine together. It has the feature of high output, high cutting precision (cutting error is under 1mm), easy operation, smooth welding corner etc.

Large Diameter Pipe Equipment Series

1. High Efficiency Single-Screw Extruder
2. Large-diameter Gas/Water Supply Pipe Machine (φ20-2000mm)
3. Large-diameter Drain Pipe (Krah Pipe) Equipment
4. Large-diameter Winding Pipe Production Line (φ300-3000mm)
5. PE/PVC Multilayer Composite Pipe Machine
6. PERT/PPR High-speed Pipe Production Line
7. PPR- Glass Fiber- PPR Pipe Production Line
8. Plastic Pipe Mould

• Sport Used Dependable Performance Football Artificial Grass Making Machine

- This unit is made of:
Wire drawing machine
Knitting machine
Twisting machine
Lamination machine.
- Suitable for:
Sports Lawn: football, baseball, hockey, softball, track fields and other sports fields.
Leisure Lawn: interior decoration, garden landscape and building greening.



• Plastic Grass Mat Making Machine

- It consists of automatic feeding system/ Single screw extruder/ Two layer Flat die head / Forming system/ Haul off unit/ Shaping unit/ Trimming cutting unit/ Winder/ PLC control system. All electric parts adopts famous brand which is SIEMENS/SCHNEIDER/OMRON which can ensure equipment operation stability.
- Plastic grass is mainly used indoor and decoration, such as artificial lawn, decoration for windowsill and balcony, plastic mat of the living room and bedroom etc. Shoes-cleaning mat, etc. It is beautiful, non-toxic, convenient for maintenance. Also it can be used in mining industry. For example: gold washing industry.

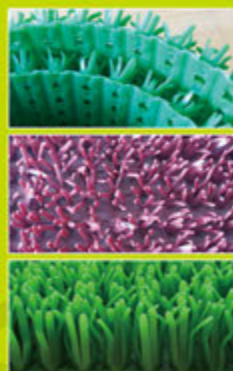

朗博机械
LANGBO MACHINERY



EXTRUSION SOLUTION



RECYCLING SOLUTION



MIXING SOLUTION



LANGBO MACHINERY

ZHANGJIAGANG LANGBO MACHINERY CO., LTD.

ADD: No.99, LEFENG ROAD, LEYU TOWN, ZHANGJIAGANG, CHINA. Tel/Fax: +86 512 5857 8311

English Cell: +86 13921986345 E-mail: info@langbochina.com Http:// www.langbochina.com

Http://www.zxextruder.com

E-mial: info@china-zhenxiong.com

TEL:0086-532-822313636 FAX:0086-532-82210563

24-hour sales hotline:0086-13573895163/13864231818

Whatsapp/ Viber/ IMO: +86 13864231818

Add:No. 678, Hangzhou Road ,Jiaozhou, Qingdao,China



☑ SX-800/1300/1500 HIGH EFFICIENCY PP, PS PP FOAMING MULTI-LAYER CO EXTRUDED SHEET UNIT



☑ SX3-D-PP, PS SHEET EXTRUDER UNI MOULD 800

Add: Yuehua Industry Area, Chaoshan Road, Shantou City, Guangdong province, China
 Mob: +86-13531276287
 Fax: +86-754-82499740
 QQ: 1483099956



☑ SX-DC-135PET HIGH-SPEED SHEET MACHING

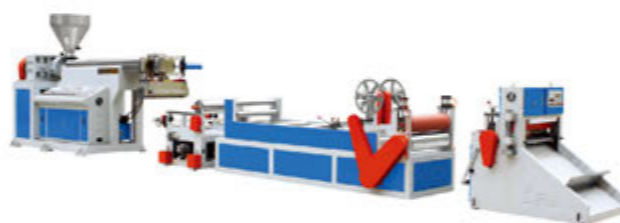

☑ SX3-D-PP, PS SHEET EXTRUDER UNIT MOULD 1500



☑ HIGH SPEES PP POLYPROPYLENE BAG BLOWING MACHINE



口罩自带、松紧绳织带机
 earloop and elastic cords making machine

挤出机系列

Cable & Wire Extrusion Series

铜线、拉线、镀锡生产设备系列
 Copper Processing Equipment Series

绞线、对绞、退扭、成缆设备系列
 Twisting, Pair-twisting, back twisting, cabling equipment series

口罩材料生产设备系列
 Mask Material Production Equipment Series

各类辅助设备
 Various Auxiliary Device



口罩鼻架条(全鼻、单鼻、双鼻)挤出生产线
 face mask raw material, nose wire extrusion production line



Dongguan Lima machinery Industrial Co., LTD is a professional r&d manufacturer of wire and cable equipment, main equipments: nose wire extruder, elastic making machine, hard and soft pipe extruding machine, PVC pipe extruder, Electronic wire power cord extrusion equipment and other ancillary equipments, which are applied to making metal nose wire, plastic nose wire, round and flat elastic ear loop, all kinds of plastic twist ties and PVC pipe, etc.

电话Tel: 0769-82279986 (82279885)

地址Add: 广东省东莞市沙田镇大泥管理区金玉组150号
 No. 150, Jinyu Group, Dani Precinct, Shatian Town, Dong Guan City Guangdong Province

网址http: www.lm-extruder.com

手机Phone: +86 15007699356

Skype:dglm88 Email:dglm@outlook.com

PVC/WPC Profile Extrusion Production Line

Линия для производства профилей из ДПК/ПВХ

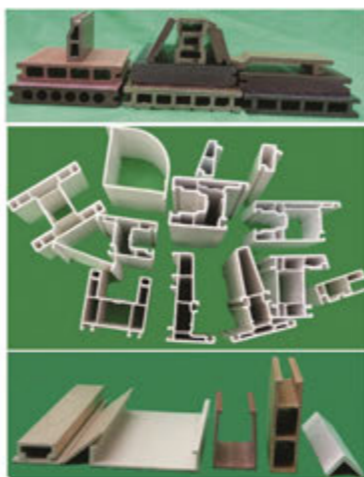

PVC/WPC Window/Door Extrusion Production Line

Линия для производства Дверей/Окна из ДПК/ПВХ

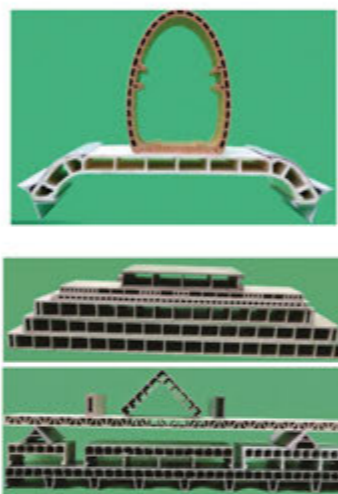

Waste paper-plastic package recycling production line(Tetra Pak)

Линия для переработки отходы бумаго-полимерная упаковка (Тетра Пак)



material

final product

QINGDAO POWERTECH MACHINERY CO., LTD.

Address: No.10-501 of Tentime Financial Plaza, No.333 of Macao Road, Jiaozhou city, Qingdao, China

Website: www.powertechmachine.com

Email : infopowertech@126.com

Mobile/Whatsapp/Webchat:+86-15192681981

Fax : 0086-532-85211877



PLASTIC GEOMATERIALS EQUIPMENT

JUNSHENG MACHINERY

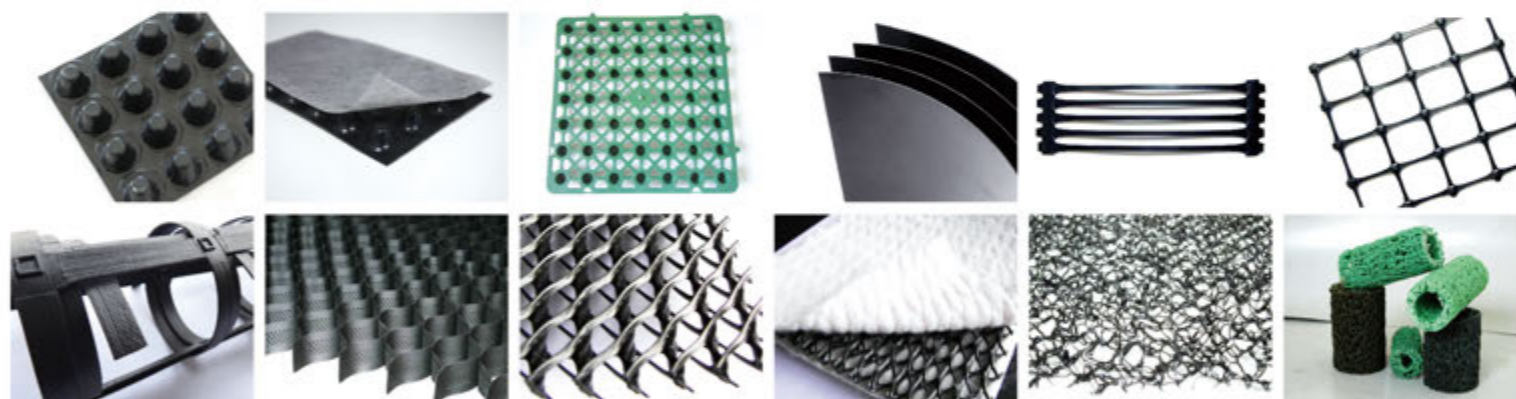

- Plastic Drainage Panel Production Line
- Injection Machine for Drainage Board
- Plastic Geomembrane Production Line
- Plastic Geogrid Production Line
- Plastic Geocell Production Line

- Full-automatic Geocell Welding Machine
- Steel Plastic Geogrid Welding Machine
- Plastic Geonet Production Line
- PVC Spinneret Carpet Production Line
- Plastic Blind Ditch Drainage Production Line

JIAXING JUNSHENG MACHINERY CO., LTD.

Add: Jiaxing City, Zhejiang Province, China

Tel: +86-573-83038972

Mob: +86-18221296578 +86-13164938888

E-mail: 803@cn-junsheng.com

Yahoo: jxjunsheng@yahoo.com

[Http://en.cn-junsheng.com](http://en.cn-junsheng.com)



NingBo KonRun Machinery Technology Co.,Ltd.

The professional Plastic Extrusion Manufacturer Of China



Products List



Booth No.:
13D51
8B-1



KR-series PVC 16-1200mm Single/Multi Layer Pipe High Speed Extrusion Line



KR-series PE 16-2400mm Water & Fuel Gas Supply and Multi Layer Pipe Super-cooling High-speed Co-extrusion Line



KR-series PVC/WPC/FOAM/SIDE Profile/Door Panel High-speed Extrusion Line



KR-series PP-R, PP, PB, PEX-B, ABS, PVDF Pipe High-speed Extrusion Line

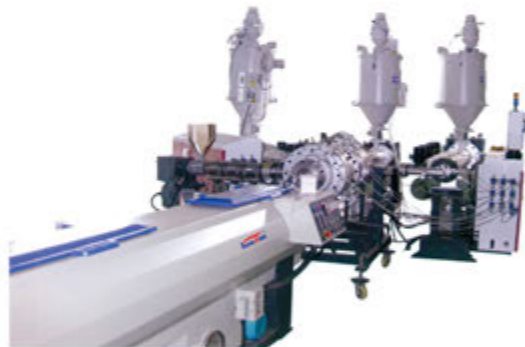

KR-series Polyolefin 3SP Multi Layer Super Silence Pipe High-speed Extrusion Line



KR-series PE-RT, PB, PE High-speed High Efficiency Extrusion Line

Main Products



- KR-series PE 16-2400 water supply, fuel gas and multi-layer co-extrusion composite pipe extrusion line
- KR-series PPR, PA11, PB, PEX, PE-RT pipe extrusion line
- KR-series PP Three-Layer Super Silence Pipe High-speed Extrusion Line
- KR-series UHMW-PE ultra high molecular weight polyethylene wear-resistant pipe extrusion line
- KR-series PVC profile product and door panel (foamed profile) high speed extrusion line
- KR-series Vinyl siding panel extrusion line

- KR-series multi-function PVC 16-1200 mining steel wire spiral pipe extrusion line
- KR-series PE 16-1200 mining pipe extrusion line
- KR-series MPP single/multi layer pipe extrusion line
- KR-series C-PVC high voltage power protection pipe extrusion line
- KR-series WPC/foamed profile/ door panel high speed extrusion line
- KR-series plastic plate (sheet) single and multi-layer extrusion line

Add: No.9 JinGu Middle Road, Yinzhou district Ningbo, China / MB: 0086-13586885979/ 13738876883/ 13738878372
 Tel: 0086-574-89021111 / 89021666 / Fax: 0086-574-89021222
 Website: <http://www.konrunchina.com> / E-mail: sales@konrunchina.com / info@konrunchina.com



pvc door and window profile extrusion line



PVC pipe production line



PET bottle crushing, washing and drying line



PET flakes pelletizing line



PVC ceiling/trunking production line



PP PE granulating line

We Focus on Plastic Pipe/Profile/Pellets Extrusion for over twenty years

ZHANGJIAGANG ABLEPLAS MACHINERY CO., LTD

Add: No.1 Tongxin Road, Leyu Town, Zhangjiagang City, Jiangsu Province, China

Zip: 215622

Tel: 0086-512-58529030/58529019/58529031

Fax: 0086-512-58651907

E-mail: service@abelplas.com





High Efficiency
Energy Saving
European Standard
Extrusion Line
PE/PP-R16-2500mm



Plastic
Recycling & Washing
Line

500-6000kg/h

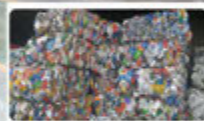

Beier Machinery Group
Zhangjiagang, China



+86 512 58682198
hdf@beierpm.com
www.beierpm.com



Intelligent
Compounding
& Conveying
System

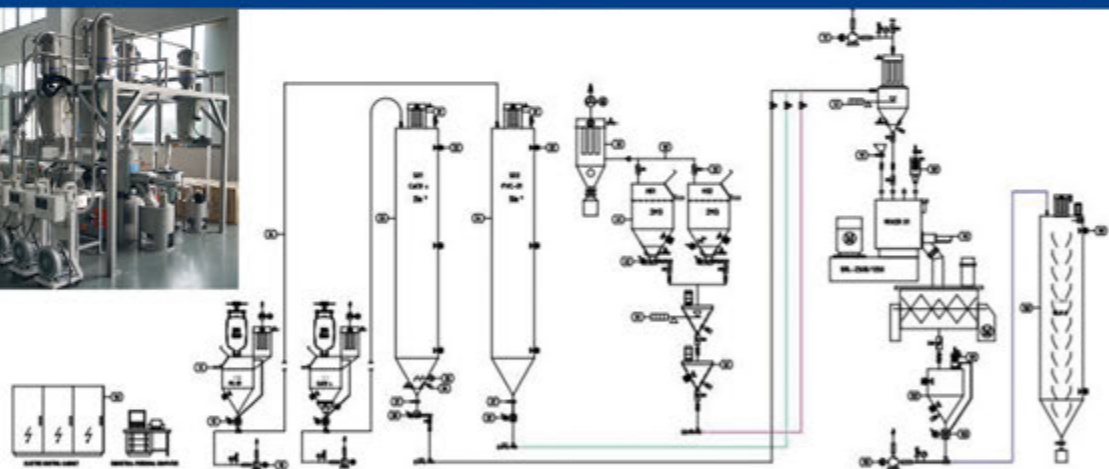

European Standard
Blow Molding
Line



FRIEND MACHINERY

Zhangjiagang Friend Machinery Co.,Ltd.

Zhangjiagang Friend Machinery Co.,Ltd is located in Zhangjiagang City near to Shanghai and Ningbo city, enjoying convenient transportation and beautiful environment. We are specialized in producing plastic machine and has rich experience in the plastic machinery making industry. Our main products include 3D filament production line, Plastic pelletizing machine, waste plastic recycling and washing machine, plastic pipe/board/profile production line and all kinds of auxiliary plastic machine. sincerely welcome friends from all over the world to visit our company and cooperate with us on the basis of long-term mutual benefits.



PET Bottle Recycling Line



Plastic Granulation Machine



Plastic Pipe Making Machine



Friend Machine, Friendship!!!

Address: No.3 Jinle Road, Jinfeng Town, Zhangjiagang City, Jiangsu Province, China
Telephone No.: +86-512-58551998
Fax No.: +86-512-58551918
Email: friend@friend2011.com
Website: www.friendmachine.com.cn

- PLASTIC RECYLING
- PLASTIC PELLETIZING
- PLASTIC COLORING



PP,PE,PET,ABS,PA,PC,PS etc plastic pelletizing machine



Film squeezer and pelletizer machine



01



High speed mixing unit

02



Shredder

03



Laser printer

04



Plastic pipe production line

05

FOCUS ON ALL KINDS OF PLASTIC RECYCLING MACHINE AND PELLETIZING MACHINE



PP,PE film&bottle, PET bottle washing line

Ningbo Hopesun Machine Co., Ltd

ADD: linshan industry park , yuyao city , zhejiang province , China
 Tel : 0086-574-62609926 Skype: machine1998
 Mobile&whatsapp : 008615888181919
 Web: www.hopesuncn.com
 Email : info@hopesuncn.com

Phone: +86-512-55379230 Cell: +86-13584439057
 Fax: +86-512-55379231 E-mail: kyle@sk-machine.com
 Address: NO.66 Baixiong Road, Sanxing Town
 Zhangjiagang City, Jiangsu Province , China



our website



SHIJIAZHUANG ZHONGSHI TESTING MACHINE CO., LTD

About us

As a professional manufacturer of non-metal testing machines, Shijiazhuang zhongshi testing machine co.,ltd was established in 1999, it's a high-tech company integrated by R&D, manufacturing, marketing, and relative service as well.

Plastic&rubber universal testing machines

- Electron universal testing machines
- Pendulum impact testing machine
- Melt flow rare testing instrument
- HDT&Vicat softening point temperature testing instrument
- Ventilated oven
- Low-temperature thermostat

Water-saving system professional testing machines

- Automatic property sprinklers test system
- Mitting-pipe/Emitting-fillet/Micro-sprinkler system integrated testing system
- Emitting pipe (fillet) pull out resistance testing machine

Plastic inspection chamber testing machines

- Pressure testing machine
- Falling Mass impact testing machine
- Negative pressure testing machine

Plastic pipes system performance testing machines

- Ring-stiffness testing machine
- Hydrostatic pressure testing machine
- Hot&cold water cycling testing machine
- Creeping ratio testing machine
- Falling mass impact testing machine
- Thermoplastic valves leakage testing machine

Plastic film testing machine & Milling machines



XGY-D Plastic Pipes Hydrostatic Pressure testing machine

Use:
It is used for testing resistance to internal pressure determination of the plastics pipes, fittings and valves. It accords with ISO1167, ISO9080, and ASTM D1598



HDT&Vicat Softening point temperature Tester

It's used for testing the HDT and vicat softening point of plastic hardrubber and some other non-metallic materials. It accords to ISO2507 ISO75, ISO306.



TLD Electron Universal testing machine

Use:
It's used for performing tension, compression, bending, shearing, peeling and tearing tests of non-metal materials and compound materials. It accords with ISO5893 ISO7500-1, ASTM D638, 695,790



Melt flow rate testing instrument

It's used for measuring the MFR and MVR of thermoplastic polymer. It accords with ISO1133



Patent NO.:ZL 2011 2 0384148.1

Plastic inspection chamber pressure testing machine

It is used for testing mechanical properties of the inspection chambers. It can take load test for the chamber body and ring-stiffness test, lateral compression test. It accords to BS EN13598.



Patent NO.:zl2013 2 000 5071.1

Emitting-pipe/Emitting-fillet/Micro-sprinkler system integrated testing system

Use:
It is used for testing resistance to internal pressure determination of the plastics pipes, fittings and valves. It accords with ISO1167, ISO9080, and ASTM D1598

Zhe Jiang Synmot Electrical Technology Co., Ltd

Add: 118 Weiliu Road, Xiaogang, Beilun, Ningbo, P.R.China

P.C: 315821

Tel: +86-574-87646791

Fax: +86-574-87646799

Http: www.synmot.com

E-mail: sales@synmot.com



■ Servo Motor



■ Servo Drive

■ Servo System



Professional Manufacturer of Servo Motors, Drives and Systems



SYNMOT ELECTRICAL



Add: 368 Xinshi North Road, Shijiazhuang, China
http://plastictester.com E-mail:sales@zhongshi-test.com

Tel: 86-311-83815090
Fax:86-311-83805354



Taizhou Luya Mold Factory

- Luya Mould is located in the moulds town of china & orange town—the coast new city Huangyan, taizhou, our company is specialized in manufacturing home appliances, automobile parts ,commodity , pallet ,turnover box, Pipe Fitting and other plastic mould.
- Customers'satisfaction is our eternal pursue. We will provide quality products and good service for every consumer. Sincerely hope to cooperate with you and create nice future.
- Sincerely welcomed domestic and overseas friends to visit our factory and do business with us.

Commodity Mould Series

Chair mould series | Stool mould series | Plastic table mould



Appliance Aarts Mould Series

Washing machine mould | Refrigerator mould
TV mould | Air conditioner mould



Various Kinds Of Commodity Mould

Turnover box series | Plastic basket series
Finishing box series | Crisper series



Add:No130,xingdong Rd,Xicheng district,Huangyan,Taizhou Tel:0576-84607665 Fax:0576-84023529
Whatsapp:13806572285 Web:www.tzluya.com Email:luyamould@aliyun.com

台州鼎翔模塑

Taizhou Huangyan Dingxiang Moud & Plastic Co.,Ltd.

20 years of professional mould manufacturer

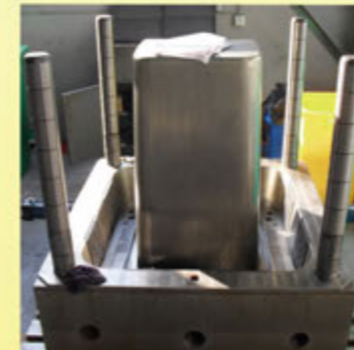
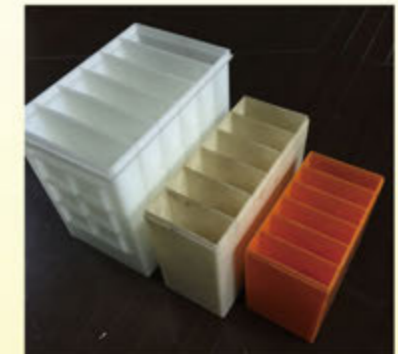
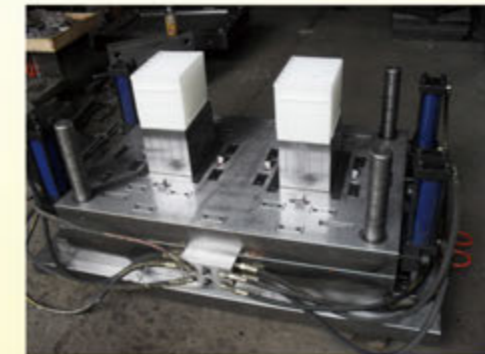

Add:No.6,Chaoyuan Rd.,West Industrial Park,Huangyan,Taizhou,Zhejiang,China.

Tel:0086-576-84289026 13676683452 (WhatsApp)

Fax:0086-576-84289027

E-mail:info@Dingxiangmould.com

Http://www.dingxiangmould.com



江南模具
GANGNAM MOULD

28 Years
Professional Experience
Focus On Plastic Mould



Professional Manufacturer
Of High-Grade Plastic Mould
高等级模具制造专家

www.gangnammould.com

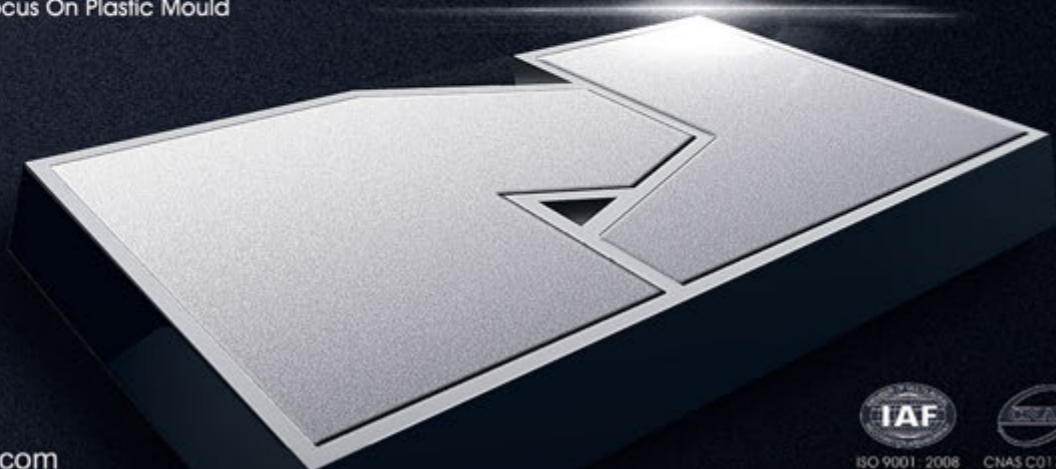

ISO 9001: 2008
NO: 11001R05



CNAS C01715Q



Automotive Mould



Appliance Mould



Logistics Mould Blowing Mould



Commodity Mould



GANGNAM MOULD CO., LTD
ZHEJIANG HUANGYAN JIANGNAN MOULD FACTORY
浙江黄岩江南模具厂



No. 228, Lehua Rd., New Industrial Zone of Mould, Xinqian,
Huangyan Dist., Taizhou, 318020, Zhejiang, China.
中国台州黄岩区(新前)模具新城乐华路228号
T: +86-576-89191368 F: +86-576-89191369
E: sales@gangnammould.com
W: www.gangnammould.com

HQMOULD®

红旗模具

ISO9001:2008



Making Mould, Making ART!

- Auto Parts Mould / 汽车件模具
- Commodity Mould / 日用品模具
- Pipe Fittings Mold / 管件模具

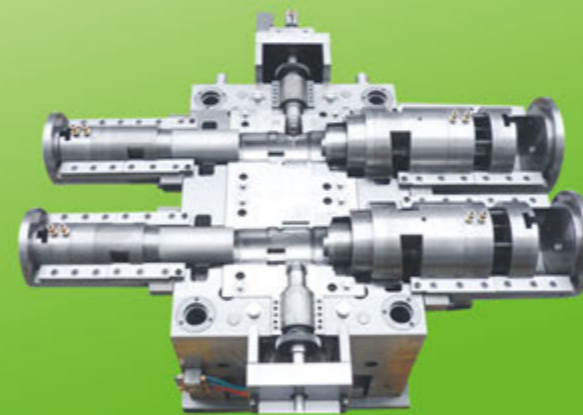

HONGQI PLASTIC MOULD FACTORY

Add: No.818 Er Huan West Road, Huangyan, Taizhou, Zhejiang, China

Overseas Contact : +86-576-81107906

M.T. : 13456680008

Fax: +86-576-84115930

Email: market@hqmould.com

www.hqmould.com





System solution for pipe fitting mould

PPR · PVC · PP-H/PP · PE
PERT · PB · PPSU · ABS



CHINA-CHUANG YUAN MOULD MANUFACTURER

Tel: +86-576-8483 2988 Whatsapp: +86-189 6860 2567
E-mail: mail@cnpipingmould.com

No.8 Xinglong Rd., West Industrial Area, Huangyan, Taizhou, Zhejiang, China
Tel: +86-576-84832977 Fax: +86-576-84081322

Website: www.cnpipingmould.com



辽宁精华新材料股份有限公司
LIAONING JINGHUA NEW MATERIAL INC.

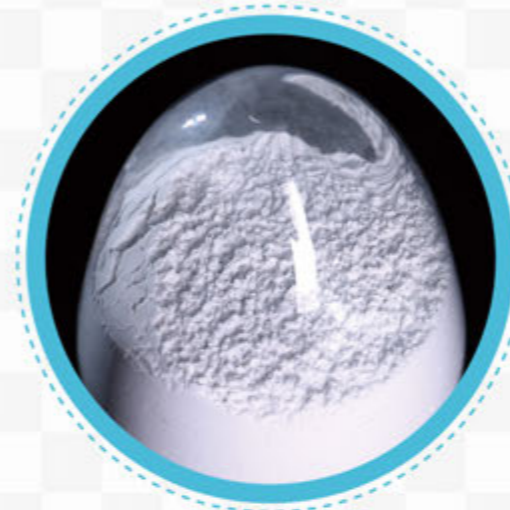

Mineral fillers
Talc
Magnesium Hydroxide
Wollastonite
Barium Sulfate



High Filling Masterbatch
90%Talc + 10% PP/PE
Application: Plastic compounding
80%Talc + 20%PE
Application: LDPE film blowing,
blow plastic, extrude sheet



WPC
Outdoor: Floor, Pavilion, Fence
Indoor: Furniture decoration board

Liaoning Jinghua New Material Inc. established in 1995. It is located in Haicheng city, Liaoning province, which is world famous for magnesite and talc. Our products include mineral filler, High filling materbatch and WPC, These products are used extensively in applications such as plastic & rubber, paint & coating, paper, cosmetics, food etc. Our sales network all over the country and our products are sold to more than 30 Countries, main market is in South-east Asia, Korea, Japan etc. We are looking forward to do business with you.

Address: No.23 Taishan St. Haicheng city, Liaong Province, China
Beijing Export Dept.: Tel: 0086-10-57839112 Fax:0086-10-57839131
Email: master@chinesetalc.com Web: www.chinesetalc.com



**WUXI CITY JIASHENG HIGH-TECH
MODIFIED MATERIAL CO.,LTD**
无锡市佳盛高新改性材料有限公司



The company is specialized in manufacturing 'Jiasheng' brand new type modifying agent of macromolecular material and Pams resin series product. The product of the enterprise can act as assistant, modifier, adhesive, agglomerant, viscosity increaser, reinforcing agent, plasticizing agent, antioxygen, disseminating agent, lubricant, high-effective fuel and heat carrier in extrusion forming and molding, applying specifically in fields such as the high flame-retarded color master batch with high-concentration and high filling, the plastic modification, the rubber and plastic shoe materials, the thermosplastic elastomer, the rubber material, the hot melt rubber, the paint and printing ink, the coating, the pigment and the precision casting, etc.

Main Products

- | | | |
|---|--|--|
| <ul style="list-style-type: none"> • Pams Resin Catena
Pams 树脂系列 • V-276 plasticizer
V-276 增塑剂 • PA-50 bright stock lube
PA-50 光亮润滑剂 • Chain transfer agent
链转移剂 • 1,1,3-Trimethyl-3-phenylindane
1,1,3-三甲基-3-苯基-茛满 • Poly p- methylstyrene
聚对甲基苯乙烯 • Styrenated phenols
防老剂 SP • Poly ethylene wax
聚乙烯蜡 • Dibenzyl dithiocarbamate sodium formate
二苄基二硫代氨基甲酸钠 • Dibenzyl dithiocarbamate sodium formate solution
二苄基二硫代氨基甲酸钠溶液 | <ul style="list-style-type: none"> • M-80 Resin
M-80 树脂 • Acetophenone
苯乙酮 • Butyl oleate
油酸丁酯 • Green Molecular control agent linear dimer
环保型分子量调节剂-线性二聚体(替代硫醇) • 2,4-Diphenyl-4-methyl-1-pentene
2,4-二苯基-4-甲基-1-戊烯 • Ammonium thiocyanate
硫氰酸铵 • 4,4'-bis(α,α'-dimethyl phenyl)-diphenyl-lamine
防老剂 KY-405 • High efficiency lubricant
高效润滑剂 • n-butyl stearate
硬脂酸正丁酯 | <ul style="list-style-type: none"> • Poly alpha methylstyrene Resin
聚α-甲基苯乙烯树脂 • JS.ATL-95 Resin
JS.ATL-95 树脂 • Rheology Modifier
流变改质剂 • Ammonium thiosulfate
硫代硫酸铵 • Parafint Wax
沙索蜡 • α-Methylstyrene cyclodimer
α-甲基苯乙烯环二聚体 • Diphenylindene bismaleimide
二苯茛双马来酰亚胺 • Power oil entrgr-effcintagent
动力燃油节能剂 |
|---|--|--|



**Shandong Yuhong
New Pigment Co., Ltd**



- **Organic Pigment Red:**
PR2/PR8/PR21/PR22/PR23/PR31/PR48:1/PR48:2/PR48:3
/PR48:4/PR53:1/PR57:1/PR146/PR170/PR112/PR122/PR254
- **Organic Pigment Orange:**
PO13/PO16/PO34
- **Organic Pigment Yellow:**
PY1/PY3/PY12/PY13/PY14/PY74/PY81/PY83/PY174/PY139
/PY151/PY180/PY191
- **Organic Pigment Blue & Green:**
PB15:0/PB15:3/PB15:7



Shandong yuhong new pigment co.,ltd is the public company in China and professional in Red, Yellow and Orange organic pigment for almost 20 years, served more than 1000 companies or factories with 7000 tons pigments per year, The products have passed the ISO,ROHS,MSDS,TDS,PRE-REACH certificates for quality guarantee, and the pigments export to east south Asia, Europe, etc, which satisfied world-wide customer.



ISO9001 ISO14001 ISO28001

Add: E-hu Industrial Area, Dangkou Town, Wuxi City, Jiangsu, P.R. China
邮政编码(Postcode): 214116 电话(Tel): 0086-510-88748136, 88520858
网址(http): //www.wx-jiasheng.com
联系人(Attn): Peter Lee

地址: 中国江苏省无锡市锡山区荡口镇鹤湖工业园
传真(Fax): 0086-510-88748340, 512-65390573
电子邮件(E-mail): webmaster@wx-jiasheng.com
手机(pm): 0086-13338762870, 18962121918

ADD: No.6 Guoyuan Road, Tianqu Industrial Park, Dezhou city, Shandong, China.
Tel: 86-534-2342259 Fax: 86-534-2323974 Mob.:86-13853419719
Email : sales@yuhongchem.com export@yuhongchem.com
Web: www.yhpigment.com www.yuhongchem.com

Shandong Terry Supply
Chain Management Co., Ltd.

薄膜系列 | Film Series

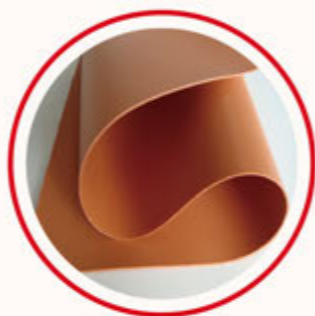

充气系列 | Inflatable Series



胶带系列 | Tape Series



Shandong Terry Supply Chain Management Co., Ltd.
Add: Room705, Creative building, No.69HaichuanRoad, High-techZone, Jining
Tel: +86-537-2310705 Mob: +86-18653713700
Web: www.tairuiplas.com E-mail: china@tairuiplas.com

CENTRAL ASIA

PLAST WORLD

The 8th International Exhibition
for Plastics Industry

23-25 november 2016

Almaty, Kazakhstan

Baluan Sholak
Exhibition Sport Palace

www.industrtyplatform.kz

Organizer



Central Asia
Trade Exhibitions
www.centralasiaexpo.kz

Organizer
Central Asia Trade Exhibitions
Almaty - KAZAKHSTAN
Zenkova str. 13, BC Forum, 2 fl. 215 office, 050010;
Tel: +7 727 266 36 80, +7 707 611 81 02/03/04
Fax: +7 727 266 36 84
info@industryplatform.kz | www.industryplatform.kz



Sinerji
International Sales & Marketing Office
Sinerji International Exhibitions.
Istanbul - TURKEY
Kaptanpasa Mah. Darulaceze Cad.
Bilas Is Merkezi No:33 B Blok 6.Kat No:65, Sisli
Tel: +90 212 210 94 85
Fax: +90 212 222 34 96



PROPAK

WEST AFRICA 2017

PACKAGING • PROCESSING • PRINTING • PLASTICS

20-22 SEPTEMBER 2017

LANDMARK CENTRE, LAGOS, NIGERIA

BOOK YOUR STAND!



PROPAK IS AFRICA'S LEADING EXHIBITION PURELY DEDICATED TO PACKAGING, PRINTING AND PLASTICS

73%
REBOOK ONSITE!

43%
VISITORS WERE MANAGING DIRECTORS OR CEOs



EXPANDING TO **1600m²** IN 2016!

130+ EXHIBITORS EXPECTED

3000 EXPECTED ATTENDEES

REASONS TO EXHIBIT:

- Meet the most influential decision makers in the industry
- Participate in focused interactive seminars
- Boost brand recognition and showcase solutions
- Network with new and existing customers

"It was definitely a good experience at Propak West Africa 2015 with meeting prospective clients. I flew from Dubai for this exhibition and it is my first time in Nigeria. I will be back next year."

Zhang Guo, Lucky Films Middle East

Contact:
George Pearson
Regional Director - West Africa
Tel. +44 207 886 3008
Email. george.pearson@montex.co.uk

Incorporating:



Brought to you by:



www.propakwestafrica.com

中国代理：广州外展国际会展有限公司

沈友琴·13556000626 QQ: 360752470



THE PACKAGING, FOOD PROCESSING, PRINTING, PLASTIC & LABELLING EXHIBITION

EXPO CENTRE
NASREC
Cape Town
SOUTH AFRICA

24-26
October
2017

中国代理：广州外展国际会展有限公司 沈友琴·13556000626 QQ: 360752470

Smart Packaging for Now and Future

PFP EXPO Sino-Pack 2017

中国国际包装工业展

2017.3.1-3

Area B, China Import & Export Fair Complex, Guangzhou, PR China



Register Now for FREE Admission!



www.ChinaSinoPack.com



www.PACKINNO.com

Concurrent Event



Organizer
ADSALE 亞式 ufi
Adsale Exhibition Services Ltd.

Visitor Enquiry
☎ (852) 2516 3343
✉ printpack.hkpr@adsale.com.hk

Exhibitor Enquiry
☎ (852) 2516 3371
✉ pfp@adsale.com.hk

f in @Sino-Pack
@PACKINNO
@SinoPack1
@PACKINNO1



WME 2016第5届立嘉国际机械展览会

The 5th Exhibition of LiJia International Machinery 2016

武汉国际塑料橡胶工业展览会

WUHAN INTERNATIONAL PLASTICS AND RUBBER INDUSTRY EXHIBITION

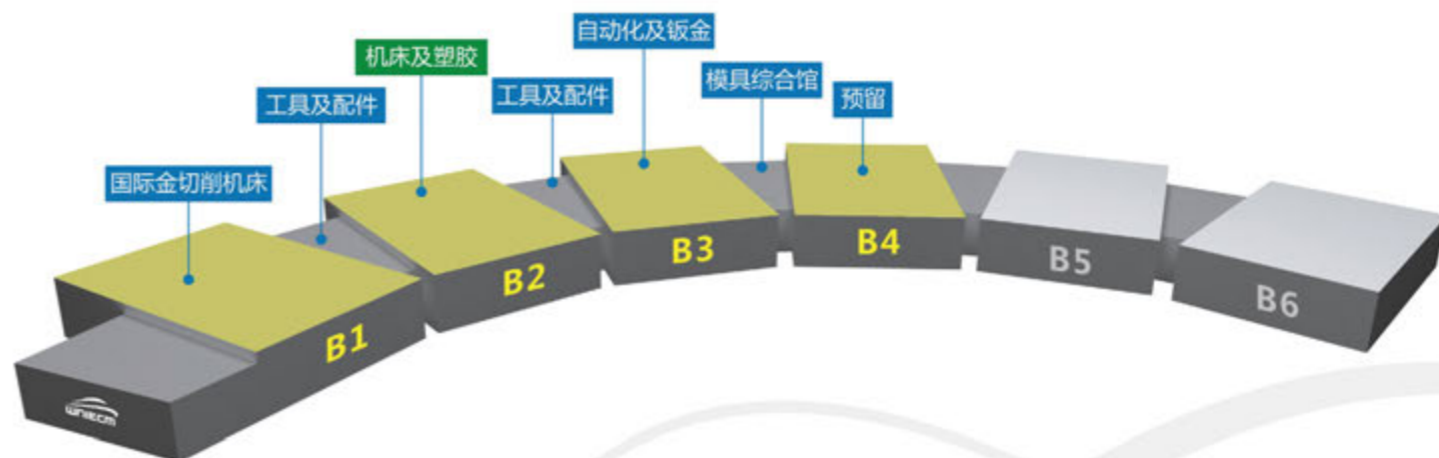

展会时间：
2016年9月23-26日
23-26, Sep, 2016

展会地址：
武汉国际博览中心（汉阳）
WUHAN INTERNATIONAL EXPO CENTER

展品类别：
橡胶胶类
塑料助剂及原辅料
塑料制品、半制成品
包装类

展会预计规模：
600家海内外知名企业
600台/套设备
观众15000人
四大展馆
展出面积40000平方米
预计展出面积比上届增加35%。

600 well-known overseas enterprises
600 sets of equipments
15,000 spectators
and four exhibition halls of 40,000 m²
exhibit area which is expected
to be 35% larger than last time.



扫一扫

湖北立嘉会议展览有限公司
Hubei Lijia Conference & Exhibition Co., Ltd.

地址：湖北省武汉市汉阳区鹦鹉大道619号国际博览中心B1馆
电话：027-84649537 传真：023-61213856
联系人：胡虹 18696117520
网址：www.wmechina.com.cn



2017

宁波高分子新材料新装备博览会 宁波国际塑料橡胶工业展览会

Ningbo polymer new material new equipment Expo
Ningbo International Plastics and Rubber Industry Expo

2017年04月20日—22日

April 20 ~ 22, 2017

宁波国际会展中心

Ningbo International Convention Center



+86-21-52270816



www.nbplas.com



2016

中国·余姚

2016年11月6-9日 中塑国际会展中心

Nov.6~9, 2016 China Plastics City International Exhibition Center

2016中国(余姚)国际塑料博览会 第十八届中国塑料博览会

China (Yuyao) International Plastics Expo 2016
The 18th China Plastics Expo

【展会规模】Expo Scale

总面积达4.2万平方米
Total area: 42,000 sqm

展位2000个 / 2015年展商近500家
2,000 Standard booths/500 Exhibitors

【展览内容】Expo Contents

塑料原料 / 塑料机械 / 机床模具
Plastics Raw Materials/Plastics Machinery
/Machine Tooling

【同期举办】To Hold Concurrently

第十二届中国塑料产业发展国际论坛
12th International Forum for
China Plastics Industry Development

【联系方式】Contact Info

余姚市中国塑料城展览有限公司
Yuyao China Plastics City Exposition Co., Ltd.

电话 (TEL): 0086-574-62537574

E-MAIL: 157859@qq.com



主办单位 Organizer



浙江省余姚市人民政府
YUYAO MUNICIPAL PEOPLE'S GOVERNMENT

构建合作平台 共享发展机遇
西部第一橡塑及包装工业展助您一臂之力



Welcome to

中国成都橡塑及包装工业展览会

The 11th China Chengdu Plastic Rubber and Packaging Industry Exhibition

2017年10月13-15日 | 13-15 October, 2017

成都世纪城新国际会展中心 | Chengdu Shiji Town New International Convention and Exhibition Center

主办单位

成都立嘉会议展览有限公司
成都市包装技术协会
四川省国防科技工业协会
成都市机械工程学会
温州市橡胶商会

成都市机械制造业商会
德阳市工商业联合会机械同业商会
成都市模具工业协会
四川省塑料制品工业协会

支持单位

中国石油天然气集团公司
中国石油化工集团公司
成都经济技术开发区模具工业协会
云南省塑料行业协会
重庆市塑料行业协会
武汉塑料行业协会
贵州省塑料工业协会
上海塑料行业协会
深圳市橡塑行业协会
湖南省塑料行业协会
安徽省塑料行业协会
四川省汽车工程学会
四川省家用电器行业协会
成都市电子行业协会
成都鞋业同业公会
温州海升机械有限公司

张家港市塑料饮料机械协会
海天塑机集团成都分公司
佛山市宝捷精密机械有限公司
宁波恩格精密机械有限公司
惠州市阳鑫塑胶机械有限公司
深圳市新劲力机械有限公司
艾尔发(苏州)自动化科技有限公司
深圳市杨森精密机械有限公司
台湾峰明机械有限公司
广东乐善机械有限公司
重庆鑫仕达包装设备有限公司
廊坊文安县凌凤塑料包装机械厂
河北华宝塑机股份有限公司
瑞安市奥翔包装机械有限公司
南安市瑞兴机电设备有限公司

执行承办单位

成都立嘉会议展览有限公司

重庆市立嘉会议展览有限公司

成都立嘉会议展览有限公司
Chengdu Lijia Conference & Exhibition Co., Ltd.

地址: 成都市高新区世纪城路920号成达佳园6栋2单元28层2号
邮编: 610040

组委会办公联系方式

联系人: 王桐 18623529057 郭华 13618242195

QQ: 2264470752

网址: www.cwsjz.com



扫描二维码 关注CDPE公众号



扫描二维码 关注CDPE官网



橡塑技术与装备

CHINA RUBBER/PLASTICS TECHNOLOGY AND EQUIPMENT

中国石油和化学工业联合会
全国橡胶塑料设计技术中心

主管 Administrative Unit: China Petroleum and Chemical Industry Federation
主办 Sponsor: National Design and Technology Center of R&P Industry

ISSN1009-797X
CN11-4534/TQ

邮发代号: 2-780 国外发行代号: M-1653
Mailing code(in China): 2-780 Overseas code:M1653

一九七五年创刊
Started publication in 1975

塑料版 (每月15日出版) Plastics edition (Published on 15th)

主要栏目

- ◆ 企业专栏
- ◆ 综述与专论
- ◆ 研究与开发
- ◆ 材料与应用
- ◆ 产品与设计
- ◆ 机械与模具
- ◆ 新技术与新产品
- ◆ 测试与研究
- ◆ 设备管理与维护
- ◆ 中外动态
- ◆ 工业自动化
- ◆ 环保节能与安全
- ◆ 企业管理
- ◆ 加工制造与过程控制
- ◆ 专利
- ◆ 标准
- ◆ Enterprise column
- ◆ Reviews and comprehensive review
- ◆ Research and development
- ◆ Materials and application
- ◆ Product and design
- ◆ Machinery and mold
- ◆ New technologies and new products
- ◆ Test and research
- ◆ Equipment management and maintenance
- ◆ Home and abroad dynamic
- ◆ Industrial automation
- ◆ Environmental protection and energy saving and safety
- ◆ Enterprise management
- ◆ Manufacturing and process control
- ◆ Patent
- ◆ Standard



橡胶版 (每月1日出版) Rubber edition (Published on 1st)

主要栏目

- ◆ 行业聚焦
- ◆ 理论与研究
- ◆ 综述与专论
- ◆ 原材料与配方
- ◆ 产品与设计
- ◆ 工艺与设备
- ◆ 机械与模具
- ◆ 新技术与新产品
- ◆ 设备管理与维护
- ◆ 中外动态
- ◆ 工业自动化
- ◆ 环保节能与安全
- ◆ 企业管理
- ◆ 工程设计
- ◆ 专利
- ◆ 标准

Main Boards

- ◆ Industry focus
- ◆ Theory and research
- ◆ Reviews and comprehensive review
- ◆ Raw materials and formulations
- ◆ Product and design
- ◆ echnology and equipment
- ◆ Machinery and mold
- ◆ New technologies and new products
- ◆ Equipment management and maintenance
- ◆ Home and abroad dynamic
- ◆ Industrial automation
- ◆ Environmental protection and energy saving and safety
- ◆ Enterprise management
- ◆ Engineering design
- ◆ Patent
- ◆ Standard

本刊参加了由中国化工信息中心、中国化工情报信息协会联合主办的“第八届全国石油和化工行业期刊评选活动”，在评比中获优秀期刊一等奖、广告奖和发行奖。

《橡塑技术与装备》是国内外公开发行的国内唯一以橡塑工艺技术、加工机械及新材料新产品为重点内容的专业技术期刊，对外发往东南亚地区及世界橡塑企业、科研机构及相关行业。国内发行遍及30个省、市、自治区的橡塑企业、科研院所、大中专院校及省市级图书馆。半月刊，定价15元/期，国际大16开，广告彩色胶印，装帧精美，是传递信息的桥梁，是介绍企业及其产品的窗口。

This magazine joined excellent publication chosen of National Petroleum and Chemical Industry jointly sponsored by China Chemical Industry Information Center and China Chemical Industry Information Association, and won second prize and award of advertisement.

This magazine is the only one R & P Industry magazine in China which reports for the Industry specially reporting the processing technology and equipment and product, materials issued with English contents and abstract domestically and abroad. This magazine is distributed in R & P enterprises, design and research institute and the some relative areas of South East Asia and the world. And it is also distributed in R & P enterprises, design and research institute, colleges and some libraries of more than 30 provinces and cities in China. This magazine is (semi monthly published) with 15 yuan per issue and international standard A4 edition with new style design and color offset printing. That is the best opening window for introducing your enterprises and products in China.

地址: 北京市海淀区半壁店59号1166室
Http: www.crpsc.com
Add: Yuntong Plaza 1166# Banbidian No.59 Haidian
Http: //www.crpsc.com

邮编: 100143
E-mail: china-rp@vip.163.com
Dist: Beijing, China 100143
E-mail: china-rp@vip.163.com

电话: 010-53100836/38
Tel: 0086-010-3100836/38

传真: 010-53100837
Fax: 0086-010-53100837

Looking Plas

Service for Plastic Industry

Join
FREE!



Mobile/Viber/WhatsApp: +86-13518676620

E-mail: service@lookingplas.com

Whatever you want in Plastic Machinery,
Moulds & Dies, Raw Materials,
Contact with LookingPlas,
We would like to supply solutions.

■ www.lookingplas.com