

# LOOKINGPLAS

[www.lookingplas.com](http://www.lookingplas.com)

K SHOW 2016

B2B Platform Focus on Plastic Machinery



EXTRUSION • RECYCLING • COMPOUNDING & CONVEYING • BLOW MOLDING

# Hall 8b E11-1

WE WALK WITH YOU TO THE SUCCESS



Display model:90/38D  
Output:950-1050KG/H(PE)

+86 512 58682198

[www.beierpm.com](http://www.beierpm.com)

[hdf@beierpm.com](mailto:hdf@beierpm.com)



**Champion (Shanghai) Plastic Machinery Co., Ltd.**  
**MGL (Shanghai) Plastic Machinery Co., Ltd.**  
**Champion (Shanghai) Imp. & Exp. Co., Ltd.**

**APET PETG CPET**

APET/PETG/PLA Sheet TWIN-SCREW  
Production Line



**PP PS**

PP /PS Sheet Production Line



**ABS HIPS**

ABS/HIPS Sheet Production Line



**Mainly Advantaged Machines:**

1. ABS/HIPS Sheet Production Lines
2. PC/PMMA/GPPS/MS Sheet Production Lines
3. PC/PP/PE Hollow Profile Production Lines
4. APET/PETG/PLA Sheet TWIN-SCREW Production Lines
5. ABS/PMMA Sheet Co-extrusion Lines
6. ABS/TPO/EVA/EPDM Sheet Production Lines
7. PP/PE Thick Board Production Lines
8. PVC Sheet Production Lines
9. WPV/PVC Foam Production Lines
10. XPS Foam Production Lines
11. PP/PS Sheet Extrusion Lines

Contact: Mr. Alen Tang  
 Mob: 0086-13916922331  
 Tel/Fax: 0086-21-39989300  
 E-mail: [championimp\\_exp@163.com](mailto:championimp_exp@163.com)  
[alen@championshcn.com](mailto:alen@championshcn.com)  
 Add: No.1945-1946, Wanqian Rd., Waigang Town,  
 Jiading District, Shanghai, China



**Innovation**  
enjoys a better value

Customized multi-flow channels design,  
intelligent and fluid visual system.  
More possibilities are created by JC Times.

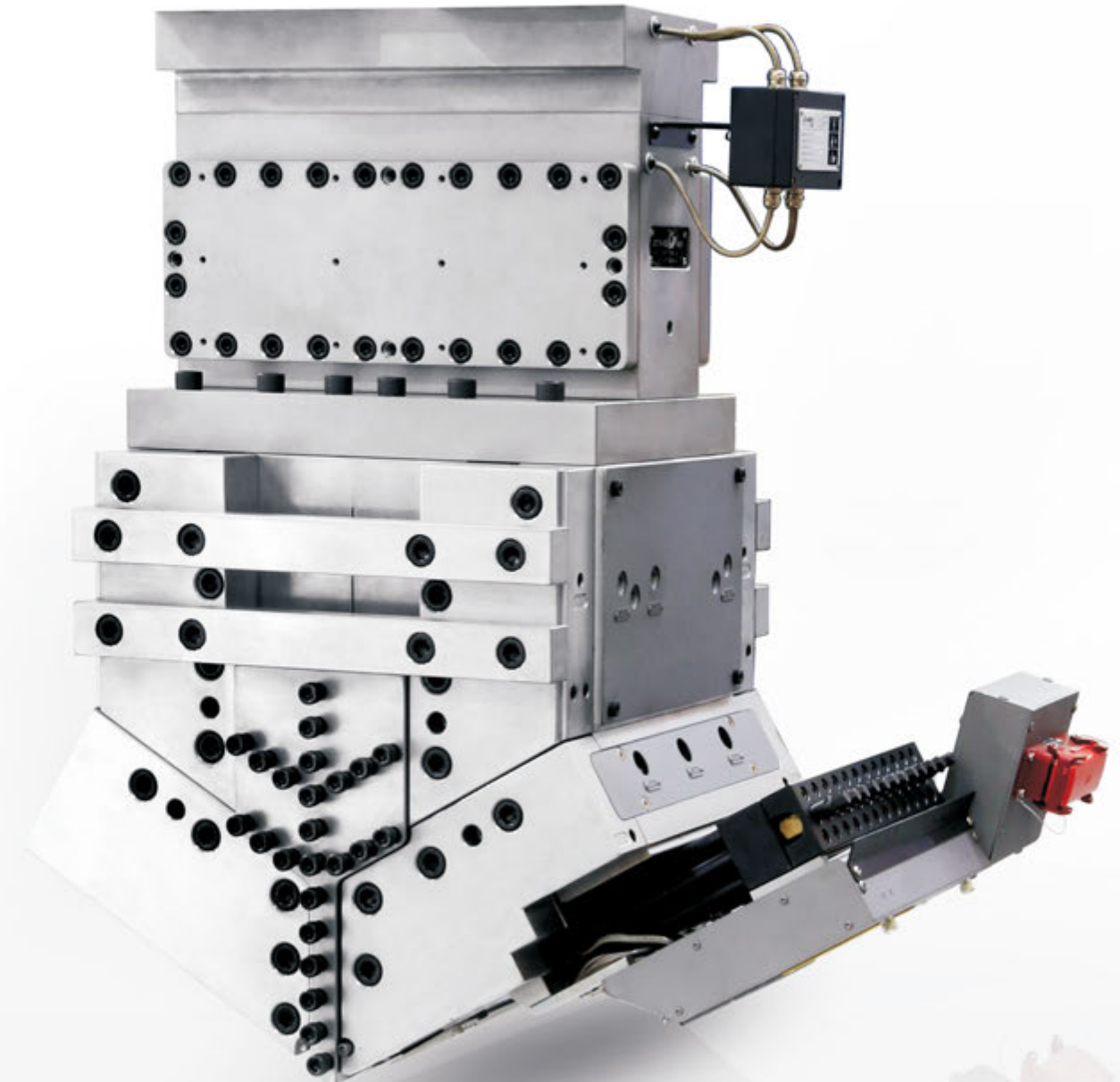

JINGCHENG TIMES GROUP  
 Email: [jc@jc-times.com](mailto:jc@jc-times.com)  
[www.jc-times.com](http://www.jc-times.com)

**JCTIMES**  
From dreams to reality





**江苏来义包装机械有限公司**  
Jiangsu Laiyi Packing Machinery Co., Ltd

**LY-ASCP型彩印包装共挤挤出复合机**  
CO-EXTRUSION COATING LAMINATING MACHINE

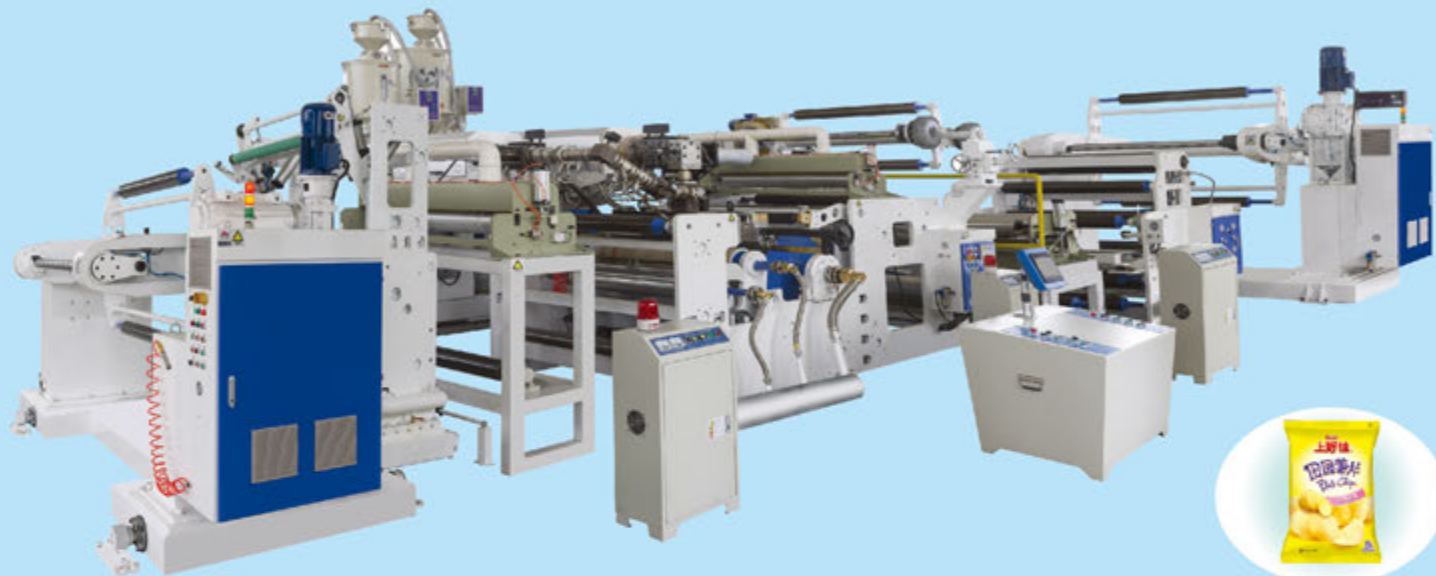

**LY-Y预涂膜专用挤出复合机**  
BOPP Laminating Film Extrusion Lamination Machine



Add: 238 East Jinsheng Road, Jintan Area, Changzhou City, Jiangsu Prov., China  
Tel: 0086-519-83138969 Fax: 0086-519-83434811 Mob: 0086-13651507296  
Contact: Liu Laiyi Web: www.laiyitrusion.com



**TAIZHOU HUANGYAN DAELONG MOLD CO., LTD**

Early from the establishment, is devoted to all kinds of preform mould, cap mould and cap compression molding machine.

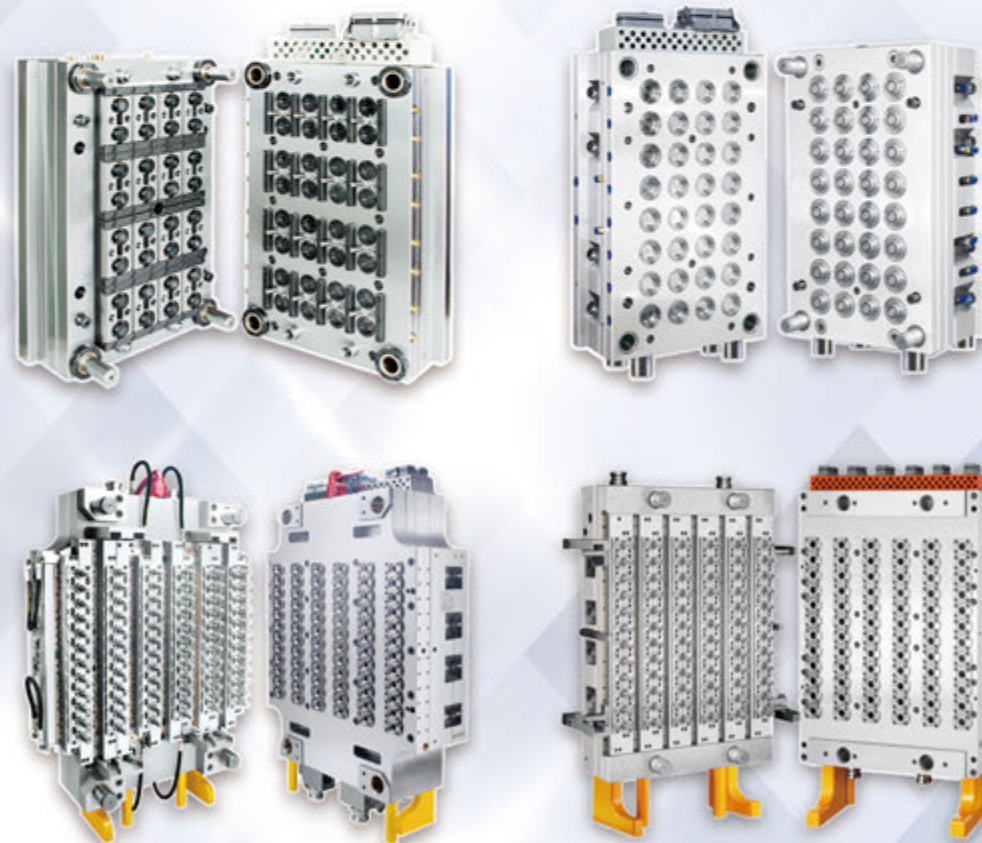

**TAIZHOU HUANGYAN DAELONG MOLD CO., LTD**

ADD: NO.58 KANGZHUANG ROAD, HUANGYAN ECONOMIC DEVELOPMENT ZONE,  
TAIZHOU CITY, ZHEJIANG, CHINA  
TEL: 0086-57684297118 0086-57684201717  
WEB: www.cndaolong.com E-mail: hengyuan@cnhengyuan.com





Huaen, supplier of engineering modified plastic fields, plastic consultant expert, the project designer and solver of new plastic materials. Our specialised fields are: lighting plastic materials, antioxidant and anti-UV materials, cold resistant materials, thermal and electrical conductive materials, infrared penetrating materials, light guide materials, and clear fireproof materials... extensively used in electrical and electronic appliances, automobiles, lighting, electric tools, decorative building materials, sports equipment, packaging, aerospace, transportation and other fields.



## CHINESE GUANGDONG HUAEN PLASTICS TECHNOLOGY CO LTD



Add: Guangdong Province Dongguan City Hengli Town  
 Malacca Industrial Park Road No. 6 Hing six  
 Tel: 86-0769-82051708  
 Fax: 86-0769-82051650  
 E-mail: huoxiaoyu@huaencn.com  
<http://www.huaentech.com>  
<http://www.huaencn.com>  
<https://dghuaen.1688.com>



## CONTENTS

### 08 SPOTLIGHT



One-step Injection Blow Molding Machine for PET, PC, PCTG, PP bottles



### Blow Molding Machine

- 08 ZHANGJIAGANG AIBIM PLASTICS MACHINERY CO., LTD.
- 09 HUANGYAN YUEXIANG MACHINERY CO., LTD.
- 10 SHANGHAI XUJIE AUTOMATION MACHINERY CO., LTD.

### 22 SPOTLIGHT

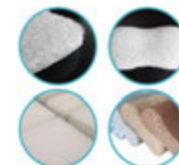

Plastic coil mattress extrusion line



### Injection Machine

- 11 HKD MACHINERY MANUFACTURE CO., LTD.

### 05 SPOTLIGHT



**CW-1000PR+OR**  
 Fully Automatic Draw Tape Garbage Bag making machine for Overlap & Perforation bag-on-roll coreless



### Extruder & Screw

- 12 ZHOUSHAN HITA PLASTIC MACHINERY CO., LTD.
- 13 ZHOUSHAN BATTEN MACHINERY TECHNOLOGY CO., LTD.
- 14 NANJING ZHUO-YUE EXTRUDERS CO., LTD.

### Film & Packing Machinery

- F2 JIANGSU LAIYI PACKING MACHINERY CO., LTD.
- 05 ZHEJIANG CHOVYTING MACHINERY CO., LTD.
- 15 LANGFANG ZHONGFENG MECHANICAL TECHNOLOGY CO., LTD.
- 16 KING-MO MACHINERY CO., LTD.
- 17 SUZHOU NEWLINE MACHINERY CO., LTD.

### More Chinese Suppliers?

1 Enter Website  
[Http://www.lookingplas.com](http://www.lookingplas.com)

2 Download LookingPlas Mobile APP



or



Scan QR Code

3 LookingPlas Magazines

### Foam Machinery

- 18 QINGDAO HEINOSKY TECHNOLOGY CO., LTD.
- 19 LONGKOU TIANHAI PRECISION MACHINERY CO., LTD.
- 20 HANGZHOU FUYANG D&T INDUSTRY CO., LTD.
- 21 QINGDAO HONGMING MACHINERY CO., LTD.
- Third Cover CHONGQING BISHAN JIECHENG PLASTIC CO., LTD.



**PANEL/PIPE/PROFILE EXTRUSION EQUIPMENT**

- Front Cover CHAMPION (SHANGHAI) IMP. & EXP. CO., LTD.
- 07 ZHANGJIAGANG CITY YILI MACHINERY CO., LTD.
- 22 ZHANGJIAGANG DIDA MACHINERY CO., LTD.
- 23 BEIER MACHINERY GROUP
- 24 DONGGUAN LIMA MACHINERY MANUFACTURING CO., LTD.
- 25 QINGDAO EAGLE MACHINERY CO., LTD.
- 26 KUNSHAN NEOTEK PLASTIC MACHINERY CO., LTD.
- 28 QINGDAO POWERTECH MACHINERY CO., LTD.
- 29 JIAXING JUNSHENG MACHINERY CO., LTD.
- 30 ZHANGJIAGANG LANGBO MACHINERY CO., LTD.
- 31 QINGDAO FRIEND PLASTIC EXTRUSION TECHNOLOGY CO., LTD.
- 32 ZHANGJIAGANG XINGJINGGANG MACHINERY CO., LTD.

**Recycling/Granulator Machine**

- 33 TAIZHOU KEFEI RUBBER-MACHINE CO., LTD.

**Ancillary Equipment**

- 34 CHANGZHOU ZHONGKE GEARBOXES MANUFACTURER CO., LTD.
- 35 SHIJIAZHUANG ZHONGSHI TESTING MACHINE CO., LTD.

**Rubber Machinery**

- 06 DALIAN YIXIANG RUBBER MACHINERY CO., LTD.

**Mould & Dies**

- F1 JINGCHENG TIMES GROUP
- F3 TAIZHOU HUANGYAN DAELONG MOLD CO., LTD.
- 03 TAIZHOU HUAYANG PLASTIC MOULD CO., LTD.
- 04 TAIZHOU HUANGYAN YONGMAO MOULD CO., LTD.
- 36 JINGHONG PLASTIC MOULD CO., LTD.
- TAIZHOU HUANGYAN TIANJIANG MOULD CO., LTD.
- 37 TAIZHOU HUANGYAN BAODA MOULD FACTORY
- 38 FORWELL PRECISION MACHINERY (NINGBO)CO., LTD.
- 39 SHENZHEN LIQI TECHNOLOGY CO., LTD.
- 40 ZHEJIANG GANGNAM MOULD CO., LTD.
- Third Cover Cross JIJA MOULD CO., LTD.

**RAW MATERIALS & AUXILIARIES**

- F4 CHINA HUAEN PLASTICS TECHNOLOGY CO., LTD.
- 41 GUANGDONG WINNER NEW MATERIALS TECHNOLOGY CO., LTD.
- 42 LIUYANG SANJI CHEMICAL CO., LTD.
- 43 QINGDAO SAINUO CHEMICAL CO., LTD.
- 44 CHANGCHUN JILIN UNIVERSITY SUPER ENGINEERING PLASTICS RESEARCH CO., LTD.
- 45 SHANDONG YUHONG NEW PIGMENT CO., LTD.

**LookingPlas Magazines**

Distribute to all the buyers for free in well-known plastic industry exhibitions.



# B2B Platform Focus on Plastic Machinery



<http://www.lookingplas.com>



• Without clear written permission of the copyright from the contributor, anyone can't copy or reprint whole or part of the magazine content by any means. The contributor is in charge of the contents and intellectual property of the manuscript. LookingPlas Group reserves the right of final explanation.



# LookingPlas in Global



Chinaplas



Thailand



Indonesia



Vietnam



Bangladesh



India



Iran



Egypt



Turkey



South Africa



Russia



Italy

PRECISION  
MOULD  
FROM  
HUAYANG

4™



INJECTION  
MOLDING  
**100-1600T**  
machines for your molding



**HUAYANG  
MOULD**

Gas Assisted Mould



TAIZHOU HUAYANG PLASTIC MOULD CO.,LTD  
Tel:86-576-84019158 E-mail:info@hy-moulds.com







# YONGMAO MOULD

Pipe Fitting Mould Construction at the Highest Technical Level



## WHAT CAN YONGMAO OFFER?

- Mould for Wastewater Systems
- Mould for Drinking Water Supply Systems
- Mould for Water & Gas Distribution Systems
- Mould for Chemical Process Industry
- Mould for Building Materials
- Mould for Exhaust Systems
- Mould for Irrigation Systems

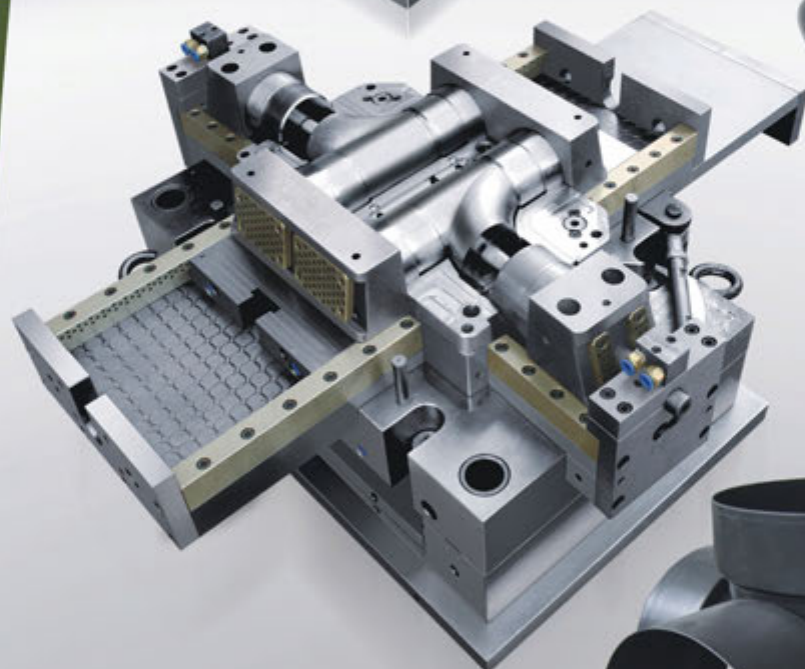
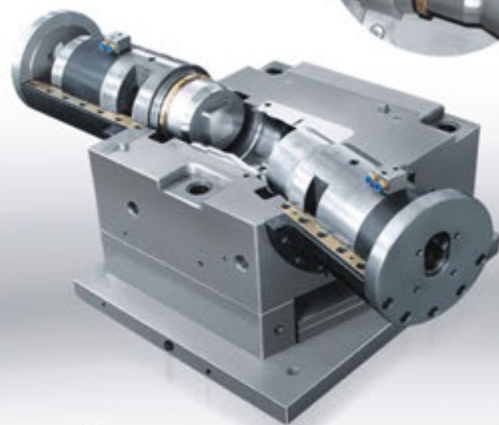

Booth No.:  
8B/G11-10



TAIZHOU HUANGYAN YONGMAO MOULD CO.,LTD.

Add: No.17 Kaiming Road, Mould New Town, Huangyan, Taizhou, Zhejiang Postcode: 318020  
Tel: +86-576-84025855 84025856  
Fax: +86-576-84025857

M.T.: +86 137 5060 2182

Http://www.yongmaomould.com  
Email: sales@yongmaomould.com  
MSN: danhong828@hotmail.com

ZHEJIANG CHOYTING MACHINERY CO., LTD



## Fully-Automatic Bag Making Machinery



**CW-800BFS**  
Wicker bag making machine



**CW-300V3**  
High speed t-shirt bag making machine



**CW-1000PR+C2**  
Automatic rolling bag making machine with and without core

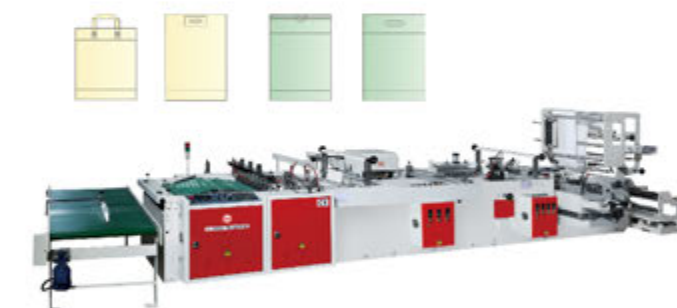

**CW-800ZD**  
Plastic handle bag making machine

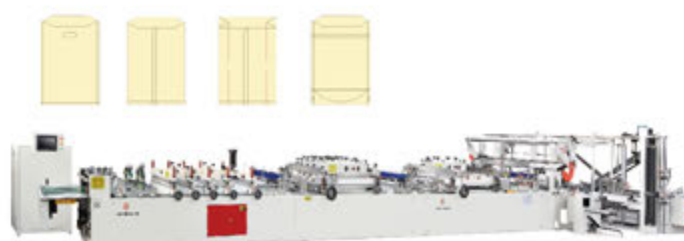

**CWZD-600C+CS**  
Automatic Multifunction Laminated Bag Making Machine

ZHEJIANG CHOYTING MACHINERY CO., LTD

Add: Jiuli Industrial Zone Shang Wang Town, Ruian City, Zhejiang Province, China  
Trade Tel: 86-577-65188131  
Fax: 86-577-65189011  
E-mail: cwding@zjchuangwei.com  
Http: //www.choyting.com







Dalian YiXiang Rubber Machinery Co.,Ltd. is a professional technical company ,which gathers in rubber machinery designing, researching, manufacturing and service.

With various of high-quality and splendid products, the company's service and achievements are highly appreciated by domestic and international customers. In China, its products has covered more than 20 provinces as well as some foreign countries for instance, Russia, Japan, South America, North America, South East Asia and South Africa and the like.



Tel: 0086-411-89441555

Fax: 0086-411-89172588

Http://www.milianji.net

E-mail:1903077910@qq.com

Add: No.198 Xinhua road ,Zhuanghe city, Dalian,Liaoning,China



## SBG200-1200 DOUBLE WALL CORRUGATED PIPE EXTRUSION LINE(HORIZONTAL TYPE)



## PE、PP FILM/WOVEN BAGS WASHING & GRANULATION LINE



## FULL AUTOMATIC WEIGHING AND CONVEYING SYSTEM

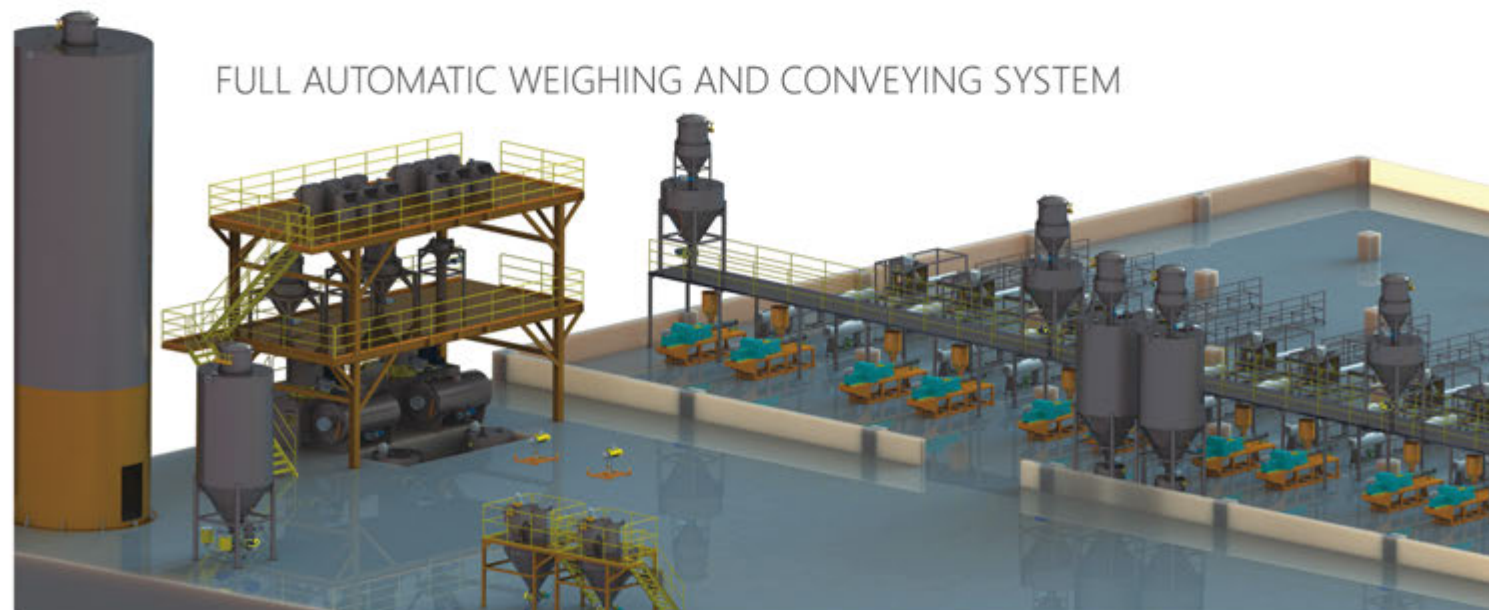

For more information, please visit [http:// www.yilimachinery.com](http://www.yilimachinery.com)  
Zhangjiagang City Yili Machinery Co.,Ltd  
E-MAIL:yilihz@yilihz.com.cn  
TEL:+86-512-58510999





**张家港市艾必模机械有限公司**  
**Zhangjiagang AiBiM Plastics Machinery Co., Ltd**  
**Injection Blow Moulding Machine & Mould**  
[Http: //ibm.en.alibaba.com](http://ibm.en.alibaba.com)  
[Http: //www.cn-ibm.com](http://www.cn-ibm.com)



⚡ Our company has absorbed the advantages of one-step blow molding machinery at home and abroad, to bring customer a higher efficiency, more energy-saving, and more stable machine, you only need to provide product drawings or samples, then we will provide you one-stop service including machine, mold, auxiliary equipment, after-sales, training, etc.



**One-step Injection Blow Molding Machine for PET,PC,PCTG,PP bottles**



⚡ **Technical Features of IBM Series One-step Blow Molding Machines:**

1. After the preform injection procedure finished, blow the bottle directly. Do not need to pack, store, transport, re-heat or do any other procedures for the preform.
2. No any flashing on the bottle mouth and bottom, no need secondary processing, to achieve perfect appearance; save the labour cost.
3. Adopt high-speed ejection and single cylinder structure, with more higher ejection speed, more accurate control, more stable weight and sizes.
4. Adopt the temperature adjustable station, which can apply to complicated shape, difficult forming products.
5. Adopt servo motor, maximally reduce energy consumption.
6. Wide range of applications, such as foods, cosmetic, pharmaceuticals, commodity, **water bottle, milk bottle, bulb**, etc.
7. Less land occupation, simple management, high automation level, less labor force (1 person can control more than 3 machines).

**WuHua Chen**

Mob: 0086-13701564739

**Zhangjiagang AiBiM Plastics Machinery Co., Ltd**

**Injection Blow Moulding Machine & Mould**

Tel : 0086-512-58433268

MSN: aibimachina@hotmail.com

Fax: 0086-512-58437296

Email: ibm@cn-ibm.com

Skype: aibimchina

Facebook/Linkedin/Whatsapp/Wechat: 0086-13701564739

Add: Tangqiao Town, Zhangjiagang City, Jiangsu, 215611, China



**跃祥机械**  
**YUEXIANG MACHINERY**  
**Taizhou Huangyan Yuexiang Machinery Co.,LTD.**

您值得信赖的吹塑机专家

YOUR RELIABLE BLOW MOLDING MACHINERY EXPERT!



Email : tzyuexiang@126.com Web : www.tzyuexiang.cn

Tel : 0086 576 84013732 Fax : 0086 576 84023932

Mob : 0086 18767625511(international trade department)

Add : Economic Development Zone of Zhuling,Huangyan,Taizhou city,Zhejiang province,China.





# Shanghai Xujie Automation Machinery Co., Ltd



Plastic Bag Automatic Pagnation Labeling Machine



Automatic Bottle Neck and Round Labeling Machine



Automatic Double Sides Labeling Machine



Automatic LiquidFilling and Linear Capping Machine

Shanghai Xujie Automation Machinery Co., Ltd is a scientific manufacturing enterprise, combined of R&D, producing, sale and service. We mainly engage in the business of researching and developing automatic producing equipment control system, and packaging equipments manufacturing.

### Mainly independent products:

- Manual/Automatic Adhesive Labeling Machine
- Shrink Sleeve Labeling Machine
- Capping Machine
- Glue Labeling Machine
- Manual/Automatic Liquid/Paste Filling Machine
- Automatic Filling Line



Add: No288, Dongzhou Rd, Dongjing, Songjiang, Shanghai, China  
 Tel: +86-21-67860304/67860284 Fax: +86-21-67860304-8006  
 Web: www.xujiepack.com www.xujzdh.com www.xujzdh.cn  
 E-mail: xujiepack@gmail xujzdh@126.com Skype:onlyyuye

M.b: +86-13362639111 / 18074185777  
 E-mail: china@hkdchina.com  
 machine@hkdchina.com  
 mould@hkdchina.com  
 Skype: hkdchina  
 Wechat: 18074185777  
 Whatsapp: 18074185777



## Order for injection molding machine, a free gift of a pair of mold



**Our company now launched a variety of payment scheme, the minimum payment of 30%, the longest installment payment time for 3 years.**

HKD machinery manufacturing co.,Ltd is located in China's largest port – ningbo. Company predecessor is ningbo industry equipments group Corporation subordinate units, is a high-tech enterprise specialized in manufacturing injection molding machine, focused on research and development of injection molding machine more than 20 years. we have experienced technical team, product design integration in Western Europe and Japan advanced technology, combined with exquisite processing technology, the main production mould clamping force of 100 t – 2200 t high precision injection molding machine, has the strong rigidity, good performance, fast response, high efficiency, energy saving, durable etc, series injection molding machine is suitable for processing high precision injection molding products, has the incomparable cost performance.

Our company is a collection research and development, production, sales and after sales for the integration of plastic packaging machinery and plastic hollow products professional manufacturers. The main business scope are: automatic plastic bottle blowing machine, PET bottle blowing machine series, high separation extrusion machine, bottle blowing machines, blow molding mould and plastic hollow products. Product design is reasonable, the modelling beautiful generous, stable and reliable performance, with the honest and trustworthy, high efficiency and energy saving, high quality and low price competitive advantage, won the favor of customers, products are exported to the country more than 20 countries, well received by customers.



## Order For Blow Molding Machine, A Free Gift Of A Pair Of Mold



HKD machinery manufacture Co.,Ltd  
 Add: No.2 road jinniu huangyan taizhou city zhejiang china





**ZHOUSHAN HITA PLASTIC MACHINERY CO.,LTD**  
 ADD.: 1st of Shantan Industrial Zone, Jintang Town, Zhoushan City, Zhejiang China  
 WhatsApp, Mobile: +86-13957213280 Email: hitascrew@163.com  
 skype: chinascREW2 www.hitascREW.com

**SCREW&BARREL MANUFACTURER**  
 FOR INJECTION MOULDING MACHINE, EXTRUSION MACHINE

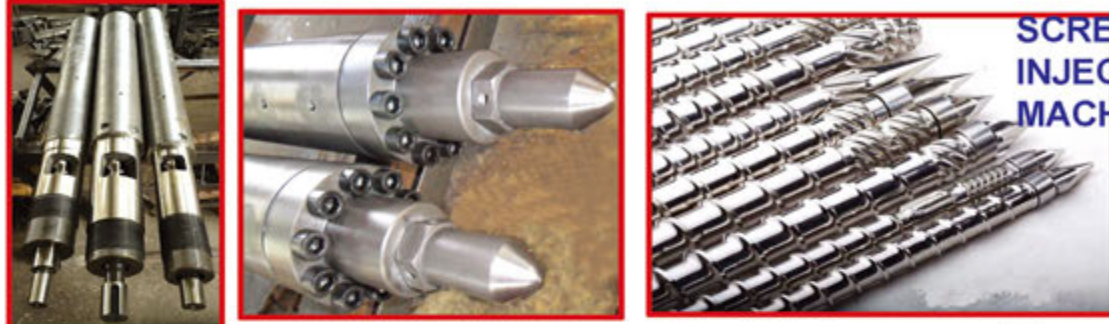

**SCREW&BARREL FOR INJECTION MOULDING MACHINE**

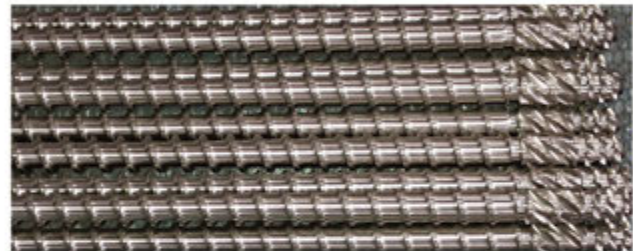

**Blow Film**  
pp,pe,  
HDPE.LDPE



**PELLETIZING**



**FOR WATER FLOWING HOLES DESIGNING**

**FEED HOLE WITH BIMETALLIC SPECIAL GROOVES FOR EASY FEEDING**

**WASTE RECYCLED FILM**   **water washed wet film**   **finished granules**

**SCREW&BARREL FOR WASHED WET FILM PELLETTIZING**

**BIMETALLIC ALLOY SPRAYED ON FEEDIGN PART**   **ALLOY SPRAYED ON EXTRUSION PART**   **SPECIAL DESIGNING SCREW**



**舟山巴顿机械科技有限公司**

**Zhoushan Batten Machinery Technology Co.,Ltd**

T:86-580-8015962 F:86-580-8015961

Web:www.batten-machinery.com

Email:batten@batten-machinery.com



**Batten,**

**Your first COOPERATOR on screw barrel.**



NanJing Zhuo-Yue extruder equipment Co.Ltd the pioneer in compounding manufacture system filed is concentrated on research and manufacture of twin screw compounding extruder system and provides the best solution in the most of application field.

**HTE Series of High Torque  
Twin Screw Compounding Extruder**

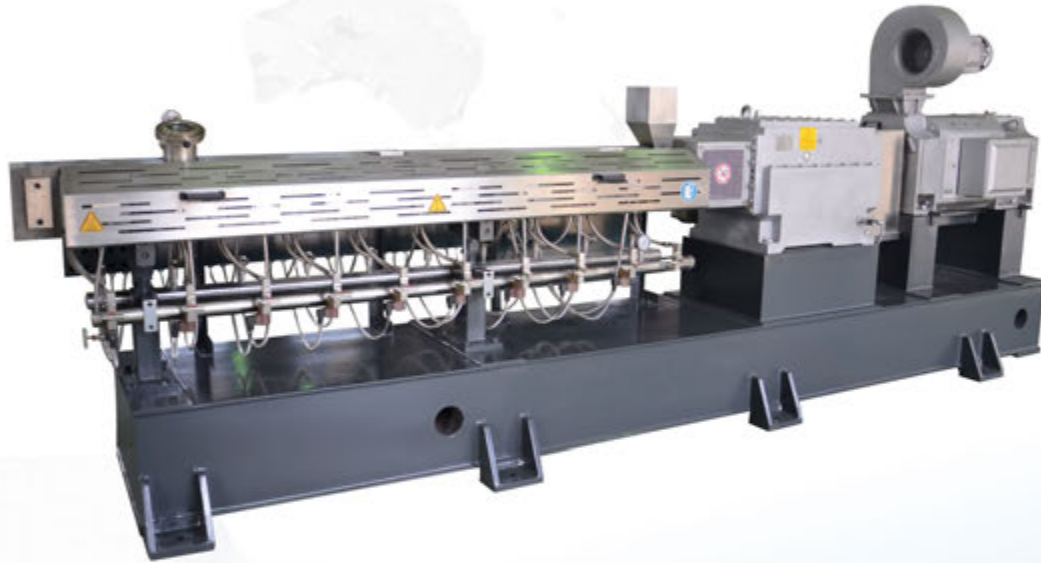

Perfect Combination Of High Performance and Quality  
Cooperation to Achieve Excellence



NANJING ZHUO-YUE EXTRUDERS CO., LTD  
E-mail: lxl@zyextruders.com  
FAX : +86-25-5270 0564  
Website: http://www.zyextruders.com

**ABA Double Screw Series Film Blowing Machine**

CNC Plastic Extrusion Control System  
ABA Three Layers Co-extrusion  
Double Screw Diameter(mm): 55x2; 60x2; 65x2  
Film Thickness(mm): 0.01-0.10



**Full Automatic Two Lines T-shirt Bag Making Machine**

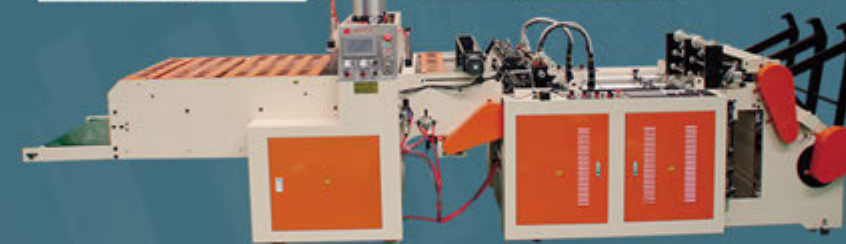

PLC Operation System  
Without Stretching Feeding  
Independent Heating Cutter  
Automatic Lubricate System

**Full Automatic Two Lines Bag On Roll Making Machine**

PLC Operation System  
Without Stretching Feeding  
Servo Motor Control  
Automatic Lubricate System



Address: Hancun Village, Daliuzhen Town, Wenan County,  
Langfang City, Hebei Province, P.R China 065800  
Tel: +86 316 5391000 Fax: +86 316 5397632  
Attn: Mr. Robin Jiao Mobile: +86 135 8246 2040  
E-mail: robin@lingfengkj.com Skype: jiaomaofeng\_1



www.lingfengkj.com



**KMM-700FB 方包袋制袋机**  
Flat Bottom Bag, Automatic Bag Making Machine



**KMM-600TSZ 高速三边封自立拉链制袋机**  
High-Speed, Three-Side-Seal, Stand Up, Zipper, Automatic Bag Making Machine



**KMM-600DC 制袋模切机组**  
Die Cutting Module



无锡鼎茂机械制造有限公司  
江苏省无锡市锡山区羊尖镇南村路28号  
No.28, Nancun Rd, Yangjian Town 214107,  
Xishan District, Wuxi, China  
Tel: +86 510 8873 7866  
Fax: +86 510 8873 7366  
Email: sales@king-mo.com

**NEWLINE MACHINERY**

Suzhou Newline Machinery Co., Ltd., invested by Jiangsu Guotai Int'l Group, is a high-tech enterprise that has absorb the foreign advanced technology and experience, in strict accordance with the national GMP requirements of working for research, design, manufacture and sales in medicine and food packaging machinery.

We specialize in viscous liquid filling/capping 2in1 machines, water/juice washing/filling/capping 3in1 machines & water treatment. We can also develop and design to conform to your needs.

We offer the best cost-effective and quality equipments.

With years of effort, our products have been exported to Asia and Africa.

**WASHING/DRYING MACHINE**

Rotary Volumetric Filling/Capping Machine is widely used in Pharmaceutical Industries, such machine can also used for Food, Oil, Chemicals & other Viscous Liquid or Syrup filling applications.

The filling Principal is Volumetric.



**TECHNICAL SPECIFICATION**

| MODEL      | Filling heads | Capping heads | Dimensions (in mm) (L x W x H) | OUTPUT (BPM on 60ml bottles) |
|------------|---------------|---------------|--------------------------------|------------------------------|
| NLMSM8-4   | 8             | 4             | 2000x1400x2000                 | 50                           |
| NLMSM12-6  | 12            | 6             | 2000x1400x2000                 | 70                           |
| NLMSM16-6  | 16            | 6             | 1900x1600x2000                 | 100                          |
| NLMSM24-8  | 24            | 8             | 2400x1900x2000                 | 150                          |
| NLMSM32-10 | 32            | 10            | 3000x2300x2000                 | 200                          |

**WASHING/FILLING/CAPPING MACHINE**

The machine is a full automatic 3in1 washing-filling-capping unit, widely used for all kinds of no gas, no viscous liquid, such as Juice, Oil, Vinegar, wine, mineral water & pure water.



**TECHNICAL SPECIFICATION**

| MODEL        | Washing/ Filling/Capping heads | Motor power (kw) | Dimensions (in mm) (L x W x H) | OUTPUT (BPH on 500ml bottles) |
|--------------|--------------------------------|------------------|--------------------------------|-------------------------------|
| NLMW16-12-6  | 16-12-6                        | 2.2              | 2400x1650x2000                 | 3500                          |
| NLMW18-18-6  | 18-18-6                        | 3.0              | 2600x1920x2000                 | 7000                          |
| NLMW24-24-8  | 24-24-8                        | 3.5              | 3100x2300x2000                 | 12000                         |
| NLMW32-32-10 | 32-32-10                       | 5.5              | 3800x2800x2000                 | 15000                         |
| NLMW40-40-10 | 40-40-10                       | 7.0              | 4600x2800x2300                 | 18000                         |
| NLMW50-50-15 | 50-50-15                       | 10.0             | 5400x3300x2500                 | 22000                         |



## External Wall Fireproof Insulation System



EPS pre-expander



EPS fire retardant coating and drying system



EPS Block moulding machine



EPS vibrating cutting machine

Qingdao Heinosky Technology Co., Ltd. Founded in 2012, which is the only one collectivization enterprise of independent research and development, manufacturing plastic machinery equipment and flame retardant technology. We adopt the high quality materials with advanced technology and professional staff, to track the actual requirements of manufacturing, with the international advanced technology development and achievement.

### ◆ Product structure diagram

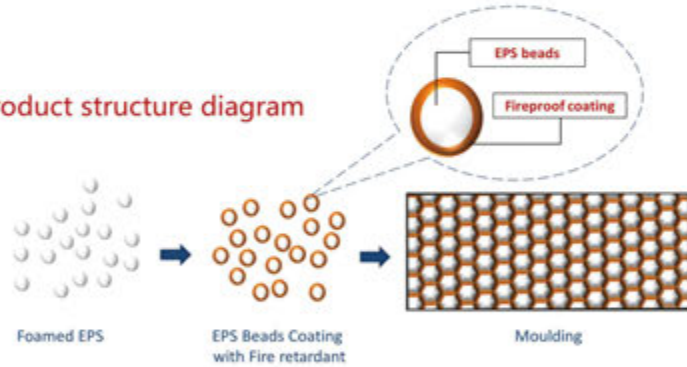

### ◆ Production process flow diagram

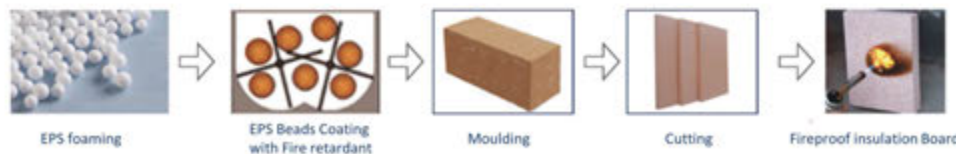

### Excellent

Fireproof Performance  
Energy Saving  
Breathable & Waterproof  
Low density  
Mechanical & physical properties

QINGDAO HEINOSKY TECHNOLOGY CO., LTD.  
ADD: NO.678 LANZHOU ROAD, JIAOZHOU, QINGDAO, CHINA  
TEL: +86-532-81123811  
FAX: +86-532-81123816  
MOBILE: +86-13678888899  
E-MAIL: SALES01@HEINOSKY.COM



Heinosky Co., Ltd.  
website QR code



Tianhai Precision Machinery

**LONGKOU TIANHAI  
PRECISION MACHINERY CO. LTD**

CE ISO9001

### Vacuum forming machine



### EPS foam cup making machine



### PS foam sheet extrusion line



## YOUR SATISFACTION IS OUR BIGGEST TARGET

Longkou Tianhai Precision Machinery Co. Ltd is one of the best professional manufacturers for PS foam fast food box (one time dishes) production line and plastic package machinery. With strong technical strength and more than 15 years experiences, our machines have already been exported to more than 30 countries and areas.

- PS fast food box production lines
- Vacuum forming machine
- EPE foam sheet production line
- PS foam sheet extrusion line
- KT board line
- Plastic laminating machine
- Hydraulic Cutting Machine
- XPS foam board extruding line
- Recycling granulators

Add: Qiwei Road, Huangcheng Industrial Park, Longkou, Shandong, China  
Tel/Fax: 0086-535-8610056/8610055 whatsapp: +8613562504605 Wechat: zHy19970501  
Web: www.yttianhai.com E-mail: sales@yttianhai.com





We are Manufacturer of  
Foam Machines from China

+86-0571-61701018

www.dtfirm.com

CNC Sponge foam Cutting Machine,  
which suitable for cutting foam into shapes

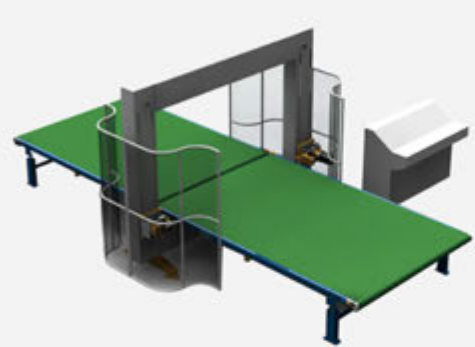

CNC Oscillating Blade  
Contour Cutter

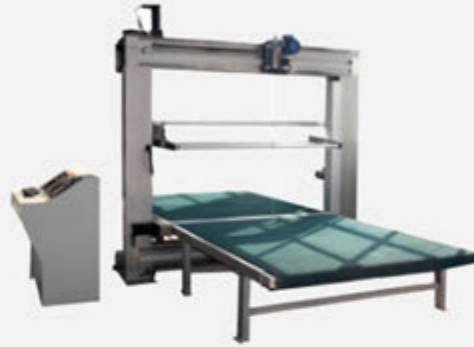

Dual Blade Oscillating Blade  
Contour Cutter



CNC Revolving Contour Cutter

| Toy Industry | Furniture | Absorbing Sponge | Make-up Sponge | Garment Industry |
|--------------|-----------|------------------|----------------|------------------|
|              |           |                  |                |                  |
|              |           |                  |                |                  |
|              |           |                  |                |                  |

**Main Application**



Qingdao HongMing Machinery Co., Ltd

## Non-crossed EPE Foam Plank Production Line



Thickness:40-110mm



Its Product Application- Packaging, Insulation, Toys, Sports, etc.

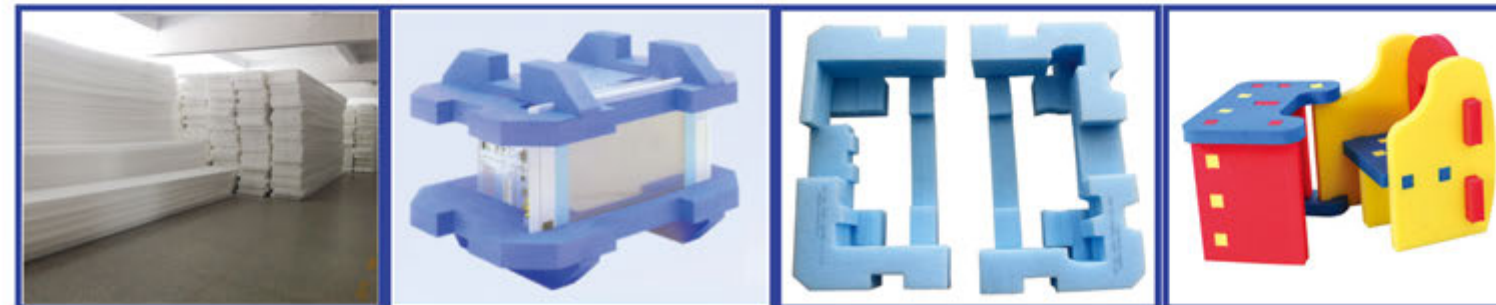

## HANGZHOU FUYANG D&T INDUSTRY CO., LTD

Web: www.dtfirm.com    www.hzdatian.en.alibaba.com  
E-mail: ming@dtfirm.com    M: +86-13588377998    Tel: +86-0571-61701018  
Add: No.20 Dongqiao Rd,Dongzhou industry area,Fuyang district, Hangzhou city,Zhejiang Province,China



E-mail:homing@homingmachinery.com  
Tel.: 86-0532-87558936  
Fax: 86-0532-87558936  
Mobile:86-18669778929  
Website: www.homingmachinery.com





张家港市帝达机械有限公司  
Zhangjiagang Dida Machinery Co.,Ltd  
张家港市帝创纤维科技有限公司  
Zhangjiagang Dichuang Fiber Technology Co.,Ltd

Our company main production equipment:



PET Sheet extrusion line



Plastic coil mattress extrusion line



Cryogenic PCL sheet extrusion line



PP Glass Fiber honeycomb board production line



Plastic Honeycomb panel extrusion line

.....  
And so on



Add: No.15,Chenfeng Road,EDA,Zhangjiagang,Jiangsu,China Http://www.didajx.com  
General sales manager: Ms Yang Mobli: +8618112699808  
Tel: +86-512-82598360 E-mail: jsszlf@126.com



Plastic  
Recycling & Washing  
Line

500-6000kg/h



www.beierpm.com



BEIER  
贝尔机械

+86 512 58682198

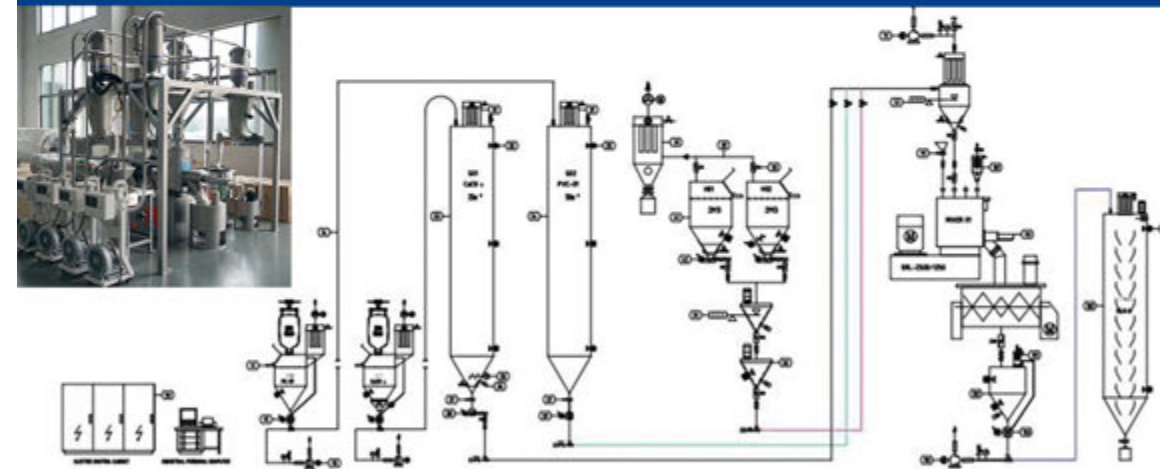

Intelligent  
Compounding  
& Conveying  
System



European Standard  
Blow Molding  
Line



BESTAR



**挤出机系列**  
Cable & Wire Extrusion Series

**铜线、拉线、镀锡生产设备系列**  
Copper Processing Equipment Series

**绞线、对绞、退扭、成缆设备系列**  
Twisting, Pair-twisting, back twisting, cabling equipment series

**口罩材料生产设备系列**  
Mask Material Production Equipment Series

**各类辅助设备**  
Various Auxiliary Device



口罩耳带、松紧绳织带机  
earloop and elastic cords making machine

Dongguan Lima machinery Industrial Co., LTD is a professional r&d manufacturer of wire and cable equipment, main equipments: nose wire extruder, elastic making machine, hard and soft pipe extruding machine, PVC pipe extruder, Electronic wire power cord extrusion equipment and other ancillary equipments, which are applied to making metal nose wire, plastic nose wire, round and flat elastic ear loop, all kinds of plastic twist ties and PVC pipe, etc.



口罩鼻梁条(全塑、单塑、双塑)挤出生产线  
face mask raw material, nose wire extrusion production line

# EAGLE

Improve forever, Technology win wealth  
Specialized in Profiles SPiral pipe technology

## HDPE/PP profiles spiral winding pipe production line

1. Adopt European latest technology, design reasonable, high configure
2. IPC control system, high automatic, software the pipe ring stiffness and weight.
3. Produce the pipe with different ring stiffness and wall structure from DN300mm to DN3500mm.
4. Change the mandrel and elements quickly and easily.
5. Supply full technology from the machine to the pipe production, fittings tank manhole and pipe installation

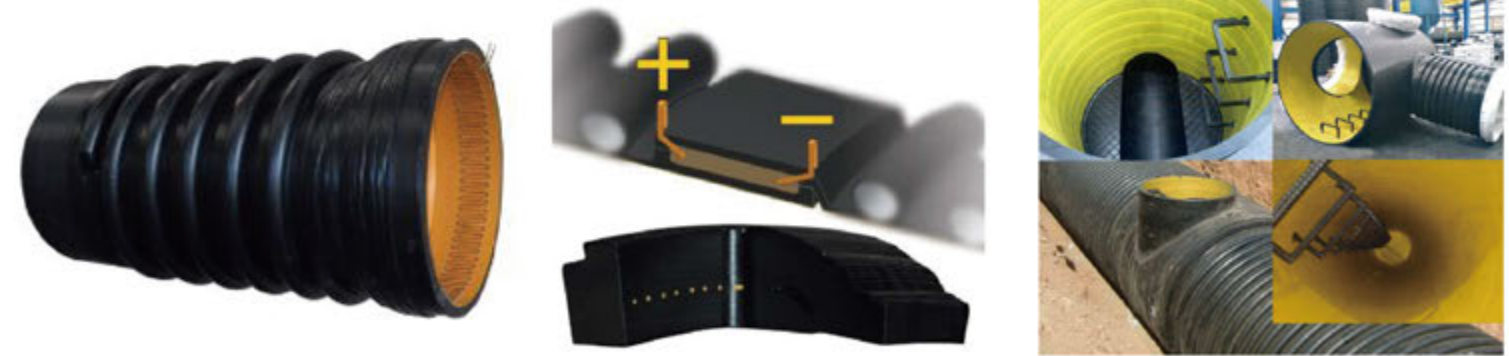
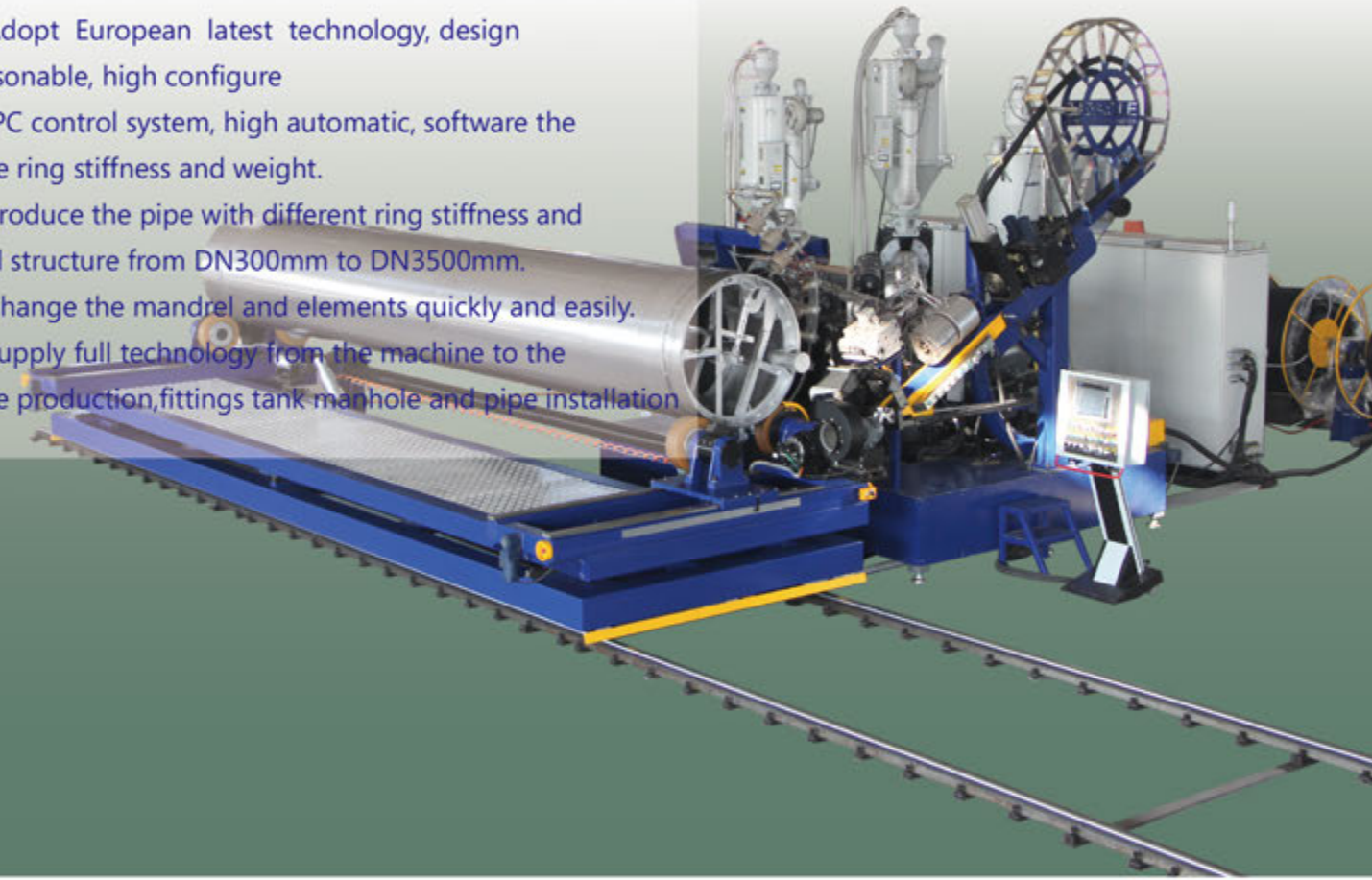

## QINGDAO EAGLE MACHINERY CO., LTD

Add: NO.258 Zhonghuan Road Fuan Industry Zone, Jiaozhou, Qingdao, Shandong, China  
Tel: 86-0532-82268513/87290108 Fax: 86-0532-82268603 Mob: +8613583232887(Mr. Zhou)  
Web: <http://www.eagle-extrusion.com> Email: [machinery@eaglegroup.cn](mailto:machinery@eaglegroup.cn)





# KUNSHAN NEOTEK PLASTIC MACHINERY CO., LTD.

BOOTH NO.  
**8 B C 3 2**

We have years of experience in design and manufacture of extrusion machinery. Our production range covering from all kind of plastic pipe extrusion line, PVC/PC profile extrusion line, PVC panel extrusion line, PVC glaze roof tile extrusion line, PVC PE PP WPC line, PVC foamed board extrusion line, etc.



Website



PVC Profile/Wall Panel Extrusion



PVC Faux Marble Sheet Extrusion Line



PVC Roof Tile Extrusion Line



PVC Foam Board Extrusion Line



Steel Wire Reinforced(twisted) Extrusion Line



PE Pipe Extrusion

PVC Pipe Extrusion Line

Add: No.99, Shaojing Road, Economic And Technological Development Zone, Kunshan, Jiangsu, China.

Tel: +86-512-5017 0679 5769 9546 5769 9348 5769 9543 Fax: +86-512-5017 0936 5769 9229

Mobile: +86-137 7317 3608 +86-151 9012 1290

Website: [www.neotekplas.com](http://www.neotekplas.com)

E-mail: [bao@neotek.cn](mailto:bao@neotek.cn) [sales@neotek.cn](mailto:sales@neotek.cn)



**PVC/WPC Profile Extrusion Production Line**

Линия для производства профилей из ДПК/ПВХ

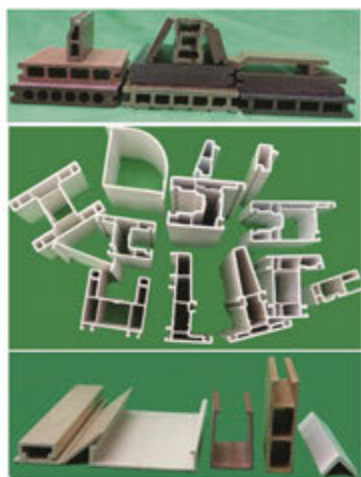

**PVC/WPC Window/Door Extrusion Production Line**

Линия для производства Дверей/Окна из ДПК/ПВХ

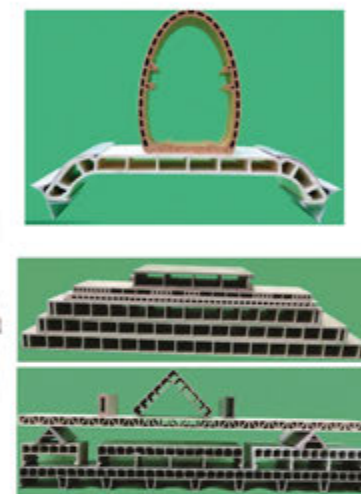

**Waste paper-plastic package recycling production line(Tetra Pak)**

Линия для переработки отходы бумаго-полимерная упаковка (Тетра Пак)



material

final product

**QINGDAO POWERTECH MACHINERY CO., LTD.**

Address: No.10-501 of Tentime Financial Plaza, No.333 of Macao Road, Jiaozhou city, Qingdao, China

Website: [www.powertechmachine.com](http://www.powertechmachine.com)

Email : [infopowertech@126.com](mailto:infopowertech@126.com)

Mobile/Whatsapp/Webchat:+86-15192681981

Fax : 0086-532-85211877



**PLASTIC GEOMATERIALS EQUIPMENT**

**JUNSHENG MACHINERY**

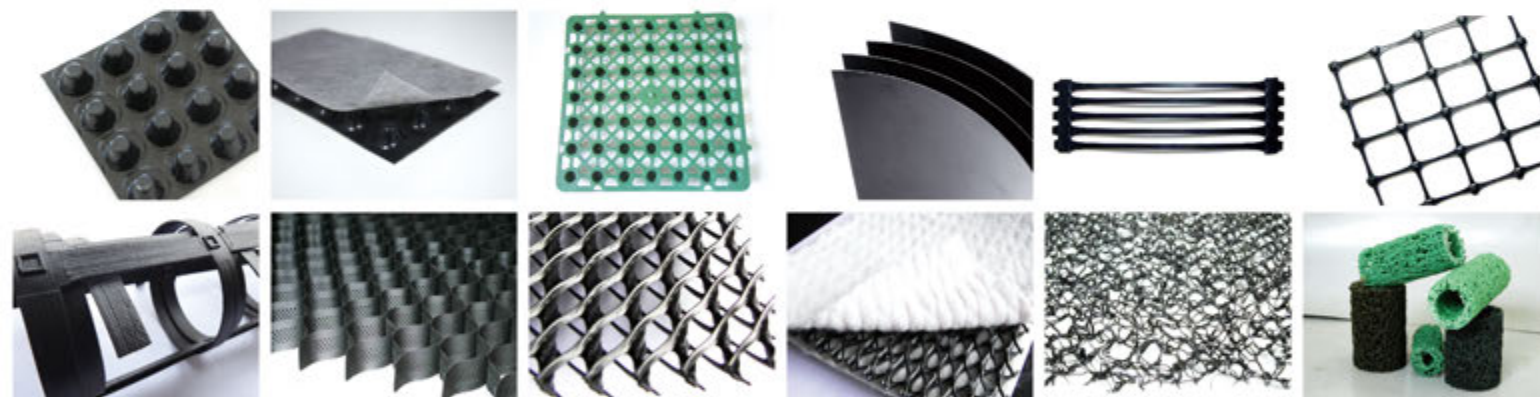

- Plastic Drainage Panel Production Line
- Injection Machine for Drainage Board
- Plastic Geomembrane Production Line
- Plastic Geogrid Production Line
- Plastic Geocell Production Line

- Full-automatic Geocell Welding Machine
- Steel Plastic Geogrid Welding Machine
- Plastic Geonet Production Line
- PVC Spinneret Carpet Production Line
- Plastic Blind Ditch Drainage Production Line

**JIAXING JUNSHENG MACHINERY CO., LTD.**

Add: Jiaxing City, Zhejiang Province, China  
E-mail: [803@cn-junsheng.com](mailto:803@cn-junsheng.com)

Tel: +86-573-83038972  
Mob: +86-18221296578  
Yahoo: [jxjunsheng@yahoo.com](mailto:jxjunsheng@yahoo.com)

+86-13164938888  
[Http://en.cn-junsheng.com](http://en.cn-junsheng.com)





朗博机械  
LANGBO MACHINERY



EXTRUSION SOLUTION



RECYCLING SOLUTION



MIXING SOLUTION

LANGBO MACHINERY

ZHANGJIAGANG LANGBO MACHINERY CO., LTD.

ADD: No.99, LEFENG ROAD, LEYU TOWN, ZHANGJIAGANG, CHINA. Tel/Fax: +86 512 5857 8311

English Cell: +86 13921986345 E-mail: info@langbochina.com Http: // www.langbochina.com



FRIEND NEW TECH  
福润德新技术

Qingdao Friend Plastic Extrusion Technology Co.,Ltd.

"FRIEND" series of extrusion lines are more energy-saving and more efficiency.

Qingdao Friend Company is a Chinese high-tech enterprise, focused on the R&D of energy efficient extrusion equipments. Our production include: water supply and drainage pipe extrusion line, sheet and board extrusion line, pelletizing line and so on.



PP/HDPE High-speed Production Line of Curved-straight-yarn for Artificial Turf



Plastic Grass Mat Production Line

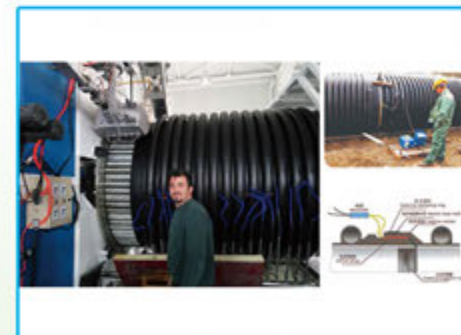

Continuous Krah Pipe Production Line



PE Water Proof Sheet (Geomembrane) Extrusion Line



PEX/AL/PEX Composite Pipe Extrusion Line

TEL: 86-532-86622397

Fax: 86-532-82206713

Mob: 86-13806392059

Email: info@fet66.com

Http: //www.fet66.com

Email: friend-an@fet66.com

Http: //www.qingdaofriend.ru





## RHD SERIES HDPE PIPE BUTT FUSION M/C



### 主要技术参数 Technical Specification

| 规格型号    | Model                            | RHD 160                        | RHD 250                                | RHD 315                           | RHD450                  | RHD500                  | RHD630                  |
|---------|----------------------------------|--------------------------------|--|-----------------------------------|-------------------------|-------------------------|-------------------------|
| 焊机范围    | Welding range(mm)                | 63, 75, 90, 110, 125, 140, 160 | 110, 125, 140, 160, 180, 200, 225, 250 | 160, 180, 200, 225, 250, 280, 315 | 280, 315, 355, 400, 450 | 315, 355, 400, 450, 500 | 400, 450, 500, 560, 630 |
| 加热板最高温度 | Heating Plate Max. Temp          | 270°C                          | 270°C                                  | 270°C                             | 270°C                   | 270°C                   | 270°C                   |
| 加热板表面温差 | Temp. Deviation in surface       | <±5°                           | <±5°                                   | <±5°                              | <±7°                    | <±7°                    | <±7°                    |
| 工作电压    | Working voltage                  | 220V, 50Hz                     | 220V, 50Hz                             | 220V, 50Hz                        | 380V, 50Hz              | 380V, 50Hz              | 380V, 50Hz              |
| 加热板功率   | Heating Plate Power              | 1.0 KW                         | 2.1 KW                                 | 3.1 KW                            | 5.2 KW                  | 5.4 KW                  | 9.2 KW                  |
| 铣刀功率    | Planing Tool Power (KW)          | 0.7 KW                         | 1.1 KW                                 | 1.1 KW                            | 1.5 KW                  | 1.5 KW                  | 1.5 KW                  |
| 液压站功率   | Heating Plate Power (KW)         | 0.75 KW                        | 0.75 KW                                | 0.75 KW                           | 1.5 KW                  | 1.5 KW                  | 1.5 KW                  |
| 总功率     | Total Power (KW)                 | 2.45 KW                        | 3.95 KW                                | 4.95 KW                           | 8.2 KW                  | 8.4 KW                  | 12.2 KW                 |
| 重量      | Weight (KGS)                     | 107 KGS                        | 143 KGS                                | 205 KGS                           | 376 KGS                 | 439KGS                  | 640 KGS                 |
| 机架尺寸    | Basic Frame Dimension (L*W*H)    | 970*505*490 mm                 | 995*600*555 mm                         | 1075*695*710 mm                   | 1485*905*1065 mm        | 1590*920*1070 mm        | 1650*1150*1280 mm       |
| 提篮尺寸    | Support Dimension (L*W*H)        | 525*525*570 mm                 | 610*590*670 mm                         | 800*655*760 mm                    | 1000*725*1350 mm        | 1020*770*1410 mm        | 1155*850*1470 mm        |
| 液压站尺寸   | Hydraulic unit Dimension (L*W*H) | 690*490*540 mm                 | 690*490*540 mm                         | 685*495*545 mm                    | 755*505*660 mm          | 770*530*540 mm          | 755*505*660 mm          |

## RHJ SERIES MUTL-ANGLE PIPE FITTING WELDING M/C



### 主要技术参数 Technical Specification

| 规格型号    | Model                                | RHJ 315  | RHJ 450                      | RHJ 630                      |
|---------|--------------------------------------|--|------------------------------|------------------------------|
| 焊机范围    | Welding range(mm)                    | 110, 125, 140, 160, 180, 200, 225, 250, 280, 315   | 250, 280, 315, 355, 400, 450 | 355, 400, 450, 500, 560, 630 |
| 焊接类型    | Welding Type                         | 0-90°弯头、正三通、正四通、45°、60°Y型正三通、斜三通(需增加可选择部件) 0-90°Elbow, tee, cross, 45°and 60°Y shape (optional parts should be used) |                              |                              |
| 加热板最高温度 | Heating Plate Max. Temp              | 270°C  | 270°C                        | 270°C                        |
| 加热板表面温差 | Temp. Deviation in surface           | <±7°   | <±7°                         | <±7°                         |
| 工作电压    | Working voltage                      | 380V, 50Hz   | 380V, 50Hz                   | 380V, 50Hz                   |
| 加热板功率   | Heating Plate Power                  | 5.25 KW  | 12 KW                        | 22 KW                        |
| 铣刀功率    | Planing Tool Power                   | 1.5 KW   | 2.2 KW                       | 2.2 KW                       |
| 液压站功率   | Hydraulic unit Power                 | 0.75 KW  | 4 KW                         | 4 KW                         |
| 总功率     | Hydraulic unit Power                 | 7.5 KW   | 18.2 KW                      | 28.2 KW                      |
| 重量      | Total Weight(Exclude optional parts) | 848KGS   | 2900KGS                      | 4470KGS                      |



科飞塑机  
KEFEIMACHINE

## TAIZHOU KEFEI RUBBER-MACHINE CO., LTD

Taizhou Kefei Rubber-Machine Co.,Ltd Sample List locates High-tech Industrial Park of Taizhou City, Jiangsu Province, covering an area of 20,000 square meters. Currently, we are the largest professional pelletizer manufacturer in China. LQ25-2000 series pelletizer is the accessory product for double(single) screw extruders, applying in water-cooling strand pelletizing for all kinds of plastic. Annual output is about 2,000 sets. The company supplies cost-effective and high quality machines for hundreds of plastic extruder manufacturers at home and abroad.



High-torque Pelletizer



Gantry Pelletizer



Boom Pelletizer

## Chinese Famous Brand Pelletizer

Add: Zhenxing Road, Gaogang Science and Innovation Park, Taizhou, Jiangsu, P.R.China  
Tel/Fax: +86-523-82989703  
Contact person: Milly Gu  
Phone/Whatsapp: +86-18061983329  
E-mail: millygu@kfrubbermachine.cn

Web: <http://www.kfrubbermachine.cn>  
Contact person: Richard Sun  
Phone/Whatsapp: +86-18961096688  
E-mail: kmplastic@km-mach.com

KEMAO  
江苏科茂机械(集团)有限公司  
Jiangsu Kemao Machinery Co., Ltd.



## ZHONGKE GEARBOXES

Plastic machinery gear box manufacturing experts

- Hardened gearbox used for plastic extruder (ZLYJ112-ZLYJ630 ZSYJ450-ZSYJ630)
- R/S/K/F series helical motor gearbox
- Open mill, internal mixer, flow membrane machine, rolling mill series reducer
- DBY, DCY series hardened reducer
- ZDY, ZSY, ZFY series gearbox for rubber and plastic machinery
- Design, research, manufacture and produce for kinds of non-standard reducer
- B series (B09-B6), X series (X1-X9) cycloid reducer and chemical reactor rack
- Electrical machinery dedicated reducer



Changzhou Zhongke Gearboxes Manufacturer Co., Ltd

Sales Tel: +86-0519 88808318 +86-13775196826

Skype: lucywang288 E-mail: gearboxes@chilunxiang.cn

Address: New Industrial Park, Wujin District, Changzhou City, Jiangsu, China

[www.chilunxiang.cn](http://www.chilunxiang.cn) <http://zhongkegearboxes.en.alibaba.com>



## About us

As a professional manufacturer of non-metal testing machines, Shijiazhuang zhongshi testing machine co.,ltd was established in 1999, it's a high-tech company integrated by R&D, manufacturing, marketing, and relative service as well.

### Plastic&rubber universal testing machines

Electron universal testing machines  
Pendulum impact testing machine  
Melt flow rare testing instrument  
HDT&Vicat softening point temperature testing instrument  
Ventilated oven  
Low-temperature thermostat

### Water-saving system professional testing machines

Automatic property sprinklers test system  
Mitting-pipe/Emitting-fillet/Micro-sprinkler system integrated testing system  
Emitting pipe (fillet) pull out resistance testing machine

### Plastic inspection chamber testing machines

Pressure testing machine  
Falling Mass impact testing machine  
Negative pressure testing machine

### Plastic pipes system performance testing machines

Ring-stiffness testing machine  
Hydrostatic pressure testing machine  
Hot&cold water cycling testing machine  
Creeping ratio testing machine  
Falling mass impact testing machine  
Thermoplastic valves leakage testing machine

### Plastic film testing machine & Milling machines



**XGY-D Plastic Pipes Hydrostatic Pressure testing machine**

Use:  
It is used for testing resistance to internal pressure determination of the plastics pipes, fittings and valves. It accords with ISO1167, ISO9080, and ASTM D1598



**HDT&Vicat Softening point temperature Tester**

Use:  
It's used for testing the HDT and vicat softening point of plastic hardrubber and some other non-metallic materials. It accords to ISO2507 ISO75, ISO306.



**TLD Electron Universal testing machine**

Use:  
It's used for performing tension, compression, bending, shearing, peeling and tearing tests of non-metal materials and compound materials. It accords with ISO5893 ISO7500-1, ASTM D638, 695,790



**Melt flow rate testing instrument**

Use:  
It's used for measuring the MFR and MVR of thermoplastic polymer. It accords with ISO1133



**Plastic inspection chamber pressure testing machine**

It is used for testing mechanical properties of the inspection chambers. It can take load test for the chamber body and ring-stiffness test, lateral compression test. It accords to BS EN13598.



**Emitting-pipe/Emitting-fillet/Micro-sprinkler system integrated testing system**

Use:  
It is used for testing resistance to internal pressure determination of the plastics pipes, fittings and valves. It accords with ISO1167, ISO9080, and ASTM D1598



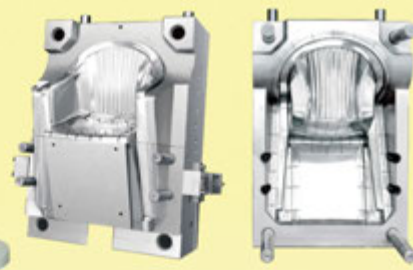

**精鸿模具**  
JINGHONG MOULD

手机: 13706572530 电话: 0576-84018526  
English phone: 15157629595  
E-Mail: sales@jinghongmould.com  
sales2@jinghongmould.com  
地址: 浙江省台州市黄岩拱新大道32号

WWW.JINGHONGMOULD.COM



**TAIZHOU HUANGYAN TIANJIANG MOULD CO.,LTD**

Changjiang Wang | Manager

☎ 86-13626667676



📍 Xinqian Zone, Huangyan, Taizhou, Zhejiang, China.

📞 86-576-81122177 📠 86-576-81122177 🌐 www.tztjmj.com 📧 tztjmj@126.com



**TAIZHOU HUANGYAN BAODA MOULD FACTORY**

PROFESSIONAL MANUFACTURER OF AUTOMOTIVE MOULD

- Front lamp mould
- Rear lamp mould
- Fog lamp mould
- Grille mould
- Bumper mould
- Rear mirror mould
- Motor vehicle accessories
- Interior/Exterior parts

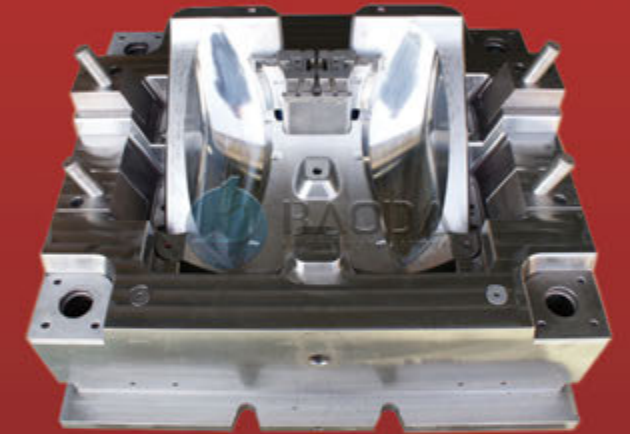
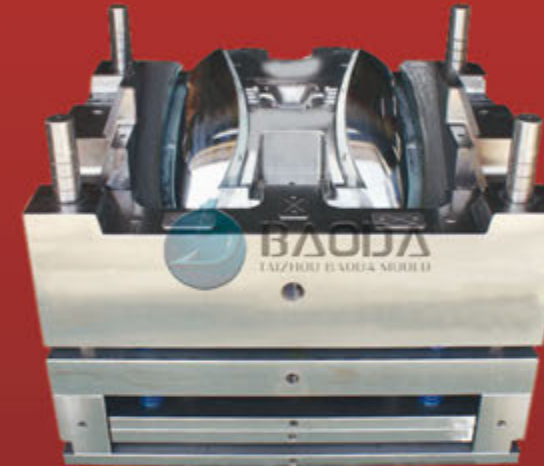

**BAODA MOULD FACTORY**

Add: xialu village, toutuo town, huangyan, taizhou, zhejiang, china 318020

Tel: +86 (0576) 84080298

Fax: +86 (0576) 84213188

Eml: sales@baoda-mould.com

sales02@baoda-mould.com

sales03@baoda-mould.com





**PFPS**  
 PCB Fine Piercing System

印刷電路板沖孔油壓脫料系統

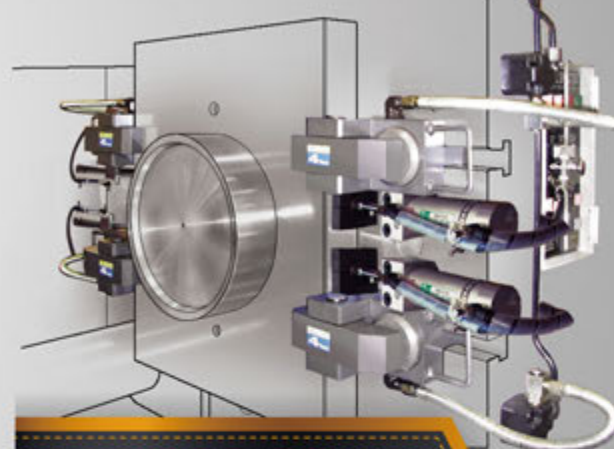

**QMCS**  
 Quick Mold Change System

射出機壓鑄機  
 快速換模系統

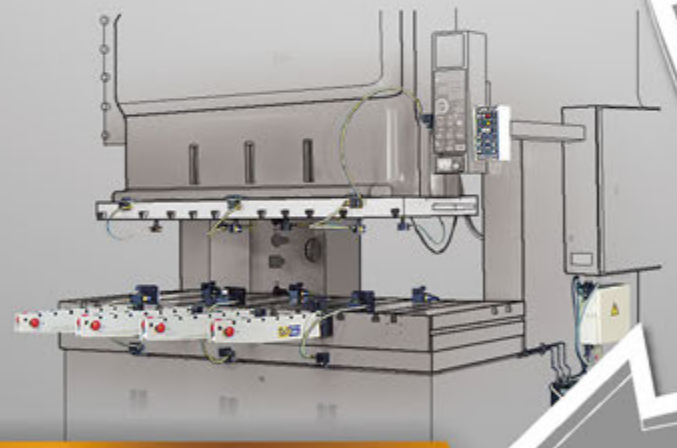

**QDCS**  
 Quick Die Change System

沖床專用快速換模系統

★★★★★  
 Granted Global Patents



**DCS/MCS**  
 Die Cart System  
 Mold Cart System

換模台車系統

**富偉精機股份有限公司**  
 FORWELL PRECISION MACHINERY CO., LTD.

台灣513彰化縣埔心鄉經口村明聖路二段399號  
 No. 399, Sec. 2, Mingsheng Rd., Pusin Township,  
 Changhua County 513, Taiwan

T +886-4-8345196  
 F +886-4-8345197  
 Skype: forwell  
 p02@forwell.com.tw

**富偉精密機械(寧波)有限公司**  
 FORWELL PRECISION MACHINERY (NINGBO) CO., LTD.

中國浙江省寧波市鎮海經濟開發區金誠路8號 郵編: 315200  
 No. 8, Jin-cheng Rd., Zhenhai Economic Development Zone,  
 Ningbo, Zhejiang, China 315200

T +86-574-8659-9196  
 F +86-574-8659-9197  
 Skype: forwellnb  
 forwell@forwellnb.com

Scan Now!



Taiwan



Video Online!



[www.liqipackaging.com](http://www.liqipackaging.com)

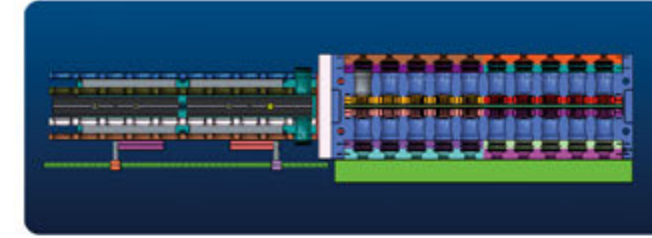

20-cavity blow mold



16-cavity injection blow mold

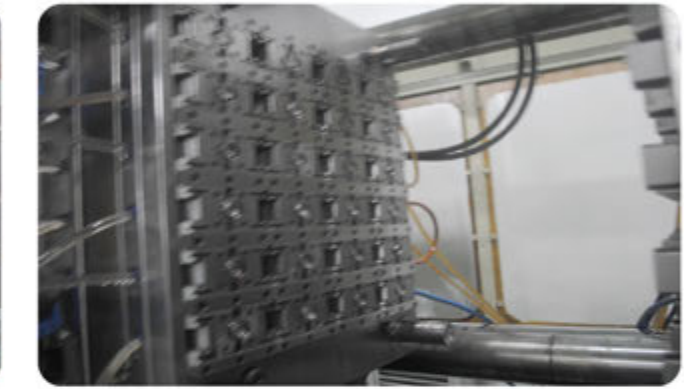

24-cavity injection cap mold

Liqi is a company dedicated to the manufacture of blow molds, injection blow molds and injection molds for plastic packaging bottles and caps. The experience acquired throughout the years have led our company to be one of the main suppliers to internationally known brands.

**We are capable of:**

- > 450 molds each year.
- > main facilities from Germany, Japan, Switzerland. main molding machines Totally 45 sets from 55 ton to 520 ton.
- > blowing molds, injection blowing molds & injection molds, multi-cavity molds, in-mold-labeling molds.
- > GMP clean-room plant for health food and nutrition packaging parts production.

# Shenzhen Liqi Technology Co., Ltd.

Lisa Luo  
 Mobile: 86-13823720052 Tel: 86-0755-27567320 Fax: 86-0755-27567326  
 Web: [www.liqipackaging.com](http://www.liqipackaging.com) Email: [Lisa.Luo@szliqi.cn](mailto:Lisa.Luo@szliqi.cn) or [lisaluo201505@gmail.com](mailto:lisaluo201505@gmail.com)  
 Add: No.75, Ditang Road, Shasan, Shajing, Bao'an District, Shenzhen, China  
 Zip code: 518104





**江南模具**  
**GANGNAM MOULD**

28 Years  
Professional Experience  
Focus On Plastic Mould



Professional Manufacturer  
Of High-Grade Plastic Mould  
高等级模具制造专家

www.gangnammould.com

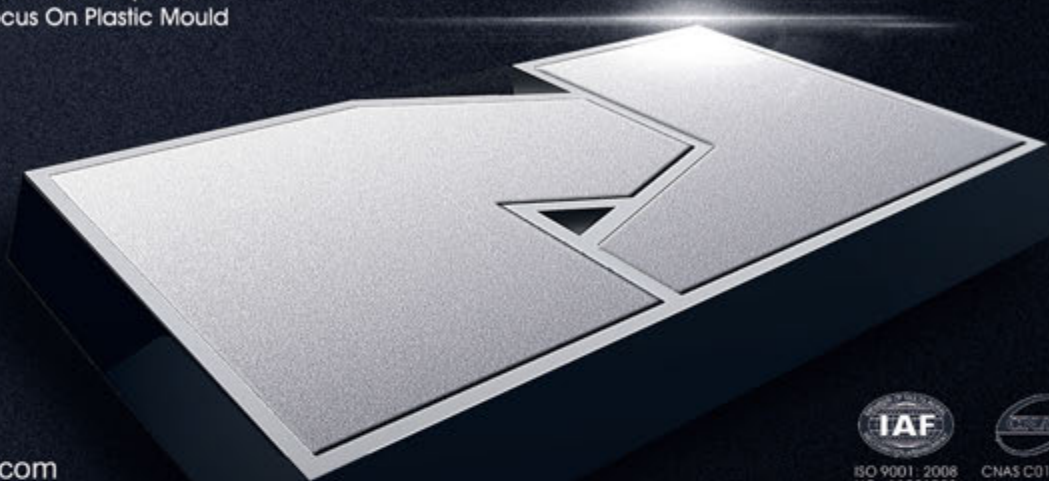

ISO 9001:2008  
NO: 11001R05



CNAS C01715Q



Automotive Mould



Appliance Mould



Logistics Mould

Blowing Mould



Commodity Mould



**GANGNAM MOULD CO., LTD**  
**ZHEJIANG HUANGYAN JIANGNAN MOULD FACTORY**  
浙江黄岩江南模具厂

No. 228, Lehua Rd., New Industrial Zone of Mould, Xinqian,  
Huangyan Dist., Taizhou, 318020, Zhejiang, China  
中国台州黄岩区(新前)模具新城乐华路228号  
T: +86-576-89191368 F: +86-576-89191369  
E: sales@gangnammould.com  
W: www.gangnammould.com



**Guangdong Winner New  
Materials Technology Co., Ltd**

CE ISO9001  
RoHS, REACH

**16 years specialized in Plastic Additive**

✓ PVC Additive

✓ Nucleating Agent

**One stop sourcing of PVC raw material**

Professional Manufacturer



PVC stabilizer



PVC compound



β nucleator

✓ R & D personnel over 50

✓ Test equipment over 80 sets

✓ Top rated automatic production equipment (capacity of 50000 MT)

**PVC Additive:**

Heat stabilizer,  
Lubricant,  
Foaming additive,  
Additive-One-Pack,  
Metallic soap, etc.

**Nucleating Agent:**

Beta nucleator,  
Clarifying agent,  
Rigidity glossiness improved nucleator.



**Factory with area over 150000 M<sup>2</sup>**



Guangdong Winner New Materials Technology Co., Ltd

Add: West Garden of Cangjiang Industry Area, Gaoming District, Foshan City, Guangdong Province, China

Email: winner@cnwinner.cn Contact: Connie Lu Mob/Whatsapp/Wechat: 0086-13630113153

Web: www.cnwinner.cn Tel: 0086-757-66852988





# 浏阳市三吉化工贸易有限公司 Liyang Sanji Chemical Co., Ltd

Liyang Sanji Chemical Co., Ltd is established in 2004, who is located in the world famous fireworks country-Liyang city, which has convenient traffic-60 kilos from Changsha that is the capital of Hunan Province.

LiuYang Sanji Chemical Co.,Ltd is the professional manufacturer and sales of Crosslinking Agent TAIC,TAC,DCP,BIPB,Flame Retardant Agent APP,TBBA,BDDP,TCPP, Plasticizer DOP,DIBP,DIBP,DBP and serial chemical additive, we have been in this industry for ten years.



Our crosslinking agent TAIC is used as cross linked modifier in PVC,PE,EVA and varied thermoplast.it is Typical using for polyethylene, polyethylene / chlorinated polyethylene, polyethylene / EVA, cross-linked polyethylene cable



and high-and low foaming products.

Crosslinked products can significantly improve the heat resistance,flame resistance,solvent resistance,mechanical strength and electrical properties.

Our manage tenet is defined as "Quality firstly, Credit uppermostly, Mutually beneficial" . we will always provide the lowest price but the newest technology、 the most handy transport、 the most flexible sales way and the best after-service, which would cooperate with customers to create future business respulence! Welcome to visit and contact us to negotiate!

### Contact information:

LiuYang Sanji Chemical Co.,Ltd

Add: B1206 Central Park, Jinsha Middle Road,  
Liyang, Hunan, China 410300

Tel: 0086-731-83616112/ 83618598

Fax: 0086-731-83668688

Email: sales@sanjichemical.com



QINGDAO SAINUO CHEMICAL CO.,LTD WHICH IS PROFESSIONAL IN MANUFACTURING PE WAX AND FISCHER TROPSCH WAX.WE HAVE REACH AND FDA REPORT.OUR MONTHLY PRODUCTION IS 1500MTS.

## FISCHER TROPSCH WAX FOR HOT MELT ADHESIVE.



PE WAX for ColorMasterbatch



PVC Products and PVC stabilizer PE WAX



PE WAX for Powder Coating



PE WAX for Road marking paint



PE WAX for Filler Masterbatch



PE WAX for Hot melt adhesive



Web:www.sainuo.en.alibaba.com EMAIL:sales@qdsainuo.com





# Changchun Jilin University Super Engineering Plastics Research Co.,Ltd

## Company profile

Changchun Jilin University Super Engineering Plastics Research Co., Ltd (JUSEP), founded in 2002, originated from Super Engineering Plastics Center of Research, State 863 project and Engineering Research Center of High Performance Plastics, Ministry of Education, is a high-tech share holding company specialized in the development, manufacture and distribution of high performance engineering plastics.

JUSEP possesses annual production capability of 100 tons of PEEK, 100 tons of PES specialty materials and modified plastics, which cover high thermo resistance grade super engineering plastics, reinforcement materials and alloys, super engineering plastics specialty resins, profile specialty materials, plastic ware and coating five series, 60 trademarks products. The products are widely used in defense industry, aerospace, automotive, petrochemical, electronics and medical fields.



**Copolymer polyether ether ketone (CoPEEK) is a semi-crystalline aromatic polymer material, and the formula of the structure is as following:**

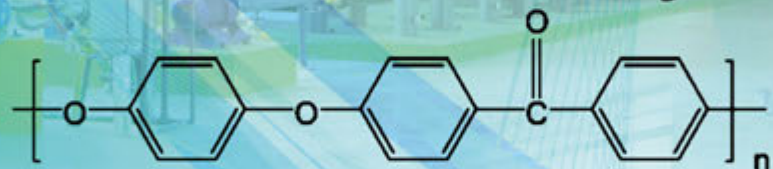

Ultrafine Powder



Neat Resin Coarse Powder



Pure Resin Granule



CF Reinforcement Aggregates



GF Reinforcement Aggregates

**Poly aryl ether sulfone resin is a non-crystalline super engineering plastic. At present, our company mainly has three types: PES, PPSU and PSU.**



PES



PES

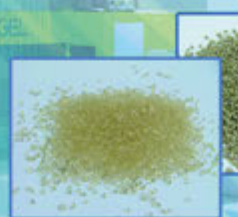

PPSU



PES+GF

ADD: NO.1288 Guanggu Street, Changchun, Jilin, P.R. China  
TEL: +86-431-87963366 +86-18343083399  
Fax: +86-431-85503211  
P.C: 130012  
E-mail: jusep@sina.com  
Http://www.jdsep.com



# Shandong Yuhong New Pigment Co., Ltd



- **Organic Pigment Red:**  
PR2/PR8/PR21/PR22/PR23/PR31/PR48:1/PR48:2/PR48:3  
/PR48:4/PR53:1/PR57:1/PR146/PR170/PR112/PR122/PR254
- **Organic Pigment Yellow:**  
PY1/PY3/PY12/PY13/PY14/PY74/PY81/PY83/PY174/PY139  
/PY151/PY180/PY191

- **Organic Pigment Orange:**  
PO13/PO16/PO34
- **Organic Pigment Blue & Green:**  
PB15:0/PB15:3/PB15:7



Shandong yuhong new pigment co., ltd is the public company in China and professional in Red, Yellow and Orange organic pigment for almost 20 years, served more than 1000 companies or factories with 7000 tons pigments per year, The products have passed the ISO, ROHS, MSDS, TDS, PRE-REACH certificates for quality guarantee, and the pigments export to east south Asia, Europe, etc, which satisfied world-wide customer.



ISO9001



ISO14001



ISO28001

ADD: No.6 Guoyuan Road, Tianqu Industrial Park, Dezhou city, Shandong, China.  
Tel: 86-534-2342259 Fax: 86-534-2323974 Mob.: 86-13853419719  
Email: sales@yuhongchem.com export@yuhongchem.com  
Web: www.yhpigment.com www.yuhongchem.com



CENTRAL ASIA  
**PLAST WORLD**

*The 8<sup>th</sup> International Exhibition  
for Plastics Industry*

**23-25 november 2016**

*Almaty, Kazakhstan*

*Baluan Sholak  
Exhibition Sport Palace*

[www.industrtyplatform.kz](http://www.industrtyplatform.kz)

**Organizer**

**Central Asia  
Trade Exhibitions**  
[www.centralasiaexpo.kz](http://www.centralasiaexpo.kz)

Organizer  
Central Asia Trade Exhibitions  
Almaty - KAZAKHSTAN  
Zenkova str. 13, BC Forum, 2 fl. 215 office, 050010;  
Tel: +7 727 266 36 80, +7 707 611 81 02/03/04  
Fax: +7 727 266 36 84  
info@industryplatform.kz | www.industryplatform.kz

**Sinerji**

International Sales & Marketing Office  
Sinerji International Exhibitions.  
Istanbul - TURKEY  
Kaptanpasa Mah. Darulaceze Cad.  
Bilas Is Merkezi No:33 B Blok 6.Kat No:65, Sisli  
Tel: +90 212 210 94 85  
Fax: +90 212 222 34 96

中国代理：广州外展国际会展有限公司

沈友琴:13556000626 QQ: 360752470

**28<sup>TH</sup>**  
**MALAYSIA  
INTERNATIONAL**

**PLASTIC MOULD  
& DIE EXHIBITION**

马来西亚国际橡塑机械暨模具展

**M'SIA-PLAS**

**27-30 JULY 2017**

**PUTRA WORLD TRADE CENTRE (PWTC)  
KUALA LUMPUR, MALAYSIA**  
吉隆坡太子世界贸易中心

**Organized by**



**Managed by**



**Endorsed by**



**The Specialized Exhibition for Your Industry**

 **+ 8613556000626**

 [www.fetchina.cn](http://www.fetchina.cn)  
 [info@fetchina.cn](mailto:info@fetchina.cn)



中国代理：广州外展国际会展有限公司

沈友琴:13556000626 QQ: 360752470





# PROPAK

## WEST AFRICA 2017

PACKAGING • PROCESSING • PRINTING • PLASTICS

20-22 SEPTEMBER 2017

LANDMARK CENTRE, LAGOS, NIGERIA

**BOOK YOUR STAND!**



PROPAK IS AFRICA'S LEADING EXHIBITION PURELY DEDICATED TO PACKAGING, PRINTING AND PLASTICS

**73%**  
REBOOK ONSITE!

**43%**  
VISITORS WERE MANAGING DIRECTORS OR CEOs



EXPANDING TO **1600m<sup>2</sup>** IN 2016!

**130+** EXHIBITORS EXPECTED

**3000** EXPECTED ATTENDEES

### REASONS TO EXHIBIT:

- Meet the most influential decision makers in the industry
- Participate in focused interactive seminars
- Boost brand recognition and showcase solutions
- Network with new and existing customers

"It was definitely a good experience at Propak West Africa 2015 with meeting prospective clients. I flew from Dubai for this exhibition and it is my first time in Nigeria. I will be back next year."

Zhang Guo, Lucky Films Middle East

Contact:  
**George Pearson**  
Regional Director - West Africa  
Tel. +44 207 886 3008  
Email. george.pearson@montex.co.uk

Brought to you by:



[www.propakwestafrica.com](http://www.propakwestafrica.com)

中国代理：广州外展国际会展有限公司

沈友琴·13556000626 QQ: 360752470



THE PACKAGING, FOOD PROCESSING, PRINTING, PLASTIC & LABELLING EXHIBITION

EXPO CENTRE  
NASREC  
Cape Town  
SOUTH AFRICA

24-26  
October  
2017

中国代理：广州外展国际会展有限公司 沈友琴·13556000626 QQ: 360752470



Smart Packaging for Now and Future

PFP EXPO **Sino-Pack 2017**  
中国国际包装工业展

2017.3.1-3

Area B, China Import & Export Fair Complex, Guangzhou, PR China



Register Now for  
FREE Admission!



[www.ChinaSinoPack.com](http://www.ChinaSinoPack.com)



[www.PACKINNO.com](http://www.PACKINNO.com)

Concurrent Event



Organizer  
**ADSALE** 亞式 ufi  
Adsale Exhibition Services Ltd.

Visitor Enquiry  
☎ (852) 2516 3343  
✉ [printpack.hkpr@adsale.com.hk](mailto:printpack.hkpr@adsale.com.hk)

Exhibitor Enquiry  
☎ (852) 2516 3371  
✉ [pfp@adsale.com.hk](mailto:pfp@adsale.com.hk)

f in @Sino-Pack  
@PACKINNO  
@SinoPack1  
@PACKINNO1

构建合作平台 共享发展机遇  
西部第一橡塑及包装工业展助您一臂之力

CPPE 2017年第11届

Welcome to

**中国成都橡塑及包装工业展览会**

The 11<sup>th</sup> China Chengdu Plastic Rubber and Packaging Industry Exhibition

2017年**10月13-15日** | 13-15 October, 2017  
成都世纪城新国际会展中心 | Chengdu Shiji Town New International  
Convention and Exhibition Center

### 主办单位

成都立嘉会议展览有限公司  
成都市包装技术协会  
四川省国防科技工业协会  
成都市机械工程学会  
温州市橡胶商会

成都市机械制造业商会  
德阳市工商业联合会机械同业商会  
成都市模具工业协会  
四川省塑料制品工业协会

### 支持单位

中国石油天然气集团公司  
中国石油化工集团公司  
成都经济技术开发区模具工业协会  
云南省塑料行业协会  
重庆市塑料行业协会  
武汉塑料行业协会  
贵州省塑料工业协会  
上海塑料行业协会  
深圳市橡塑行业协会  
湖南省塑料行业协会  
安徽省塑料行业协会  
四川省汽车工程学会  
四川省家用电器行业协会  
成都市电子行业协会  
成都鞋业同业公会  
温州海升机械有限公司

张家港市塑料饮料机械协会  
海天塑机集团成都分公司  
佛山市宝捷精密机械有限公司  
宁波恩格精密机械有限公司  
惠州市阳鑫塑胶机械有限公司  
深圳市新劲力机械有限公司  
艾尔发(苏州)自动化科技有限公司  
深圳市杨森精密机械有限公司  
台湾峰明机械有限公司  
广东乐善机械有限公司  
重庆鑫仕达包装设备有限公司  
廊坊文安县凌风塑料包装机械厂  
河北华宝塑机股份有限公司  
瑞安市奥翔包装机械有限公司  
南安市瑞兴机电设备有限公司

### 执行承办单位

成都立嘉会议展览有限公司

重庆市立嘉会议展览有限公司



扫描二维码 关注CDPE公众号



扫描二维码 关注CDPE官网

**成都立嘉会议展览有限公司**  
Chengdu Lijia Conference & Exhibition Co., Ltd.

地址: 成都市高新区世纪城路920号成达佳园6栋2单元28层2号  
邮编: 610040

### 组委会办公联系方式

联系人: 王桐 18623529057 郭华 13618242195  
QQ: 2264470752  
网址: [www.cwsjz.com](http://www.cwsjz.com)





2016  
中国·余姚

2016年11月6-9日 中塑国际会展中心

Nov.6-9, 2016 China Plastics City International Exhibition Center

# 2016中国(余姚)国际塑料博览会 第十八届中国塑料博览会 China (Yuyao) International Plastics Expo 2016 The 18th China Plastics Expo

## 【展会规模】Expo Scale

总面积达4.2万平方米  
Total area: 42,000 sqm

展位2000个 / 2015年展商近500家  
2,000 Standard booths/500 Exhibitors

## 【展览内容】Expo Contents

塑料原料 / 塑料机械 / 机床模具  
Plastics Raw Materials/Plastics Machinery  
/Machine Tooling

## 【同期举办】To Hold Concurrently

第十二届中国塑料产业发展国际论坛  
12th International Forum for  
China Plastics Industry Development

## 【联系方式】Contact Info

余姚市中国塑料城展览有限公司  
Yuyao China Plastics City Exposition Co., Ltd.

电话 (TEL): 0086-574-62537574  
E-MAIL: 157859@qq.com



### 主办单位 Organizer



# 橡塑技术与装备

CHINA RUBBER/PLASTICS TECHNOLOGY AND EQUIPMENT

中国石油和化学工业联合会  
全国橡胶塑料设计技术中心

主管 Administrative Unit: China Petroleum and Chemical Industry Federation  
主办 Sponsor: National Design and Technology Center of R&P Industry

ISSN1009-797X  
CN11-4534/TQ

邮发代号: 2-780 国外发行代号: M-1653  
Mailing code(in China): 2-780 Overseas code:M1653

一九七五年创刊  
Started publication in 1975

塑料版 (每月15日出版) Plastics edition (Published on 15th)

### 主要栏目

- |                                    |  |   |
|------------------------------------|--|---|
| ◆ 企业专栏                             | ◆ 机械与模具                                | ◆ 工业自动化   |
| ◆ 综述与专论                            | ◆ 新技术与新产品                              | ◆ 环保节能与安全   |
| ◆ 研究与开发                            | ◆ 测试与研究                                | ◆ 企业管理  |
| ◆ 材料与应用                            | ◆ 设备管理与维护                              | ◆ 加工制造与过程控制   |
| ◆ 产品与设计                            | ◆ 中外动态                                 | ◆ 专利 ◆ 标准   |
| ◆ Enterprise column                | ◆ Machinery and mold                   | ◆ Industrial automation                                 |
| ◆ Reviews and comprehensive review | ◆ New technologies and new products    | ◆ Environmental protection and energy saving and safety |
| ◆ Research and development         | ◆ Test and research                    | ◆ Enterprise management                                 |
| ◆ Materials and application        | ◆ Equipment management and maintenance | ◆ Manufacturing and process control                     |
| ◆ Product and design               | ◆ Home and abroad dynamic              | ◆ Patent ◆ Standard                                     |



全国橡塑网 全国橡塑中心 全国橡塑网 全国橡塑中心  
扫码浏览 QQ群(内部交流) 新浪微博 微信公众平台



橡胶版 (每月1日出版) Rubber edition (Published on 1st)

### 主要栏目

- |          |           |           |
|----------|-----------|-----------|
| ◆ 行业聚焦   | ◆ 工艺与设备   | ◆ 工业自动化   |
| ◆ 理论与研究  | ◆ 机械与模具   | ◆ 环保节能与安全 |
| ◆ 综述与专论  | ◆ 新技术与新产品 | ◆ 企业管理    |
| ◆ 原材料与配方 | ◆ 设备管理与维护 | ◆ 工程设计    |
| ◆ 产品与设计  | ◆ 中外动态    | ◆ 专利 ◆ 标准 |

### Main Boards

- |                                    |  |   |
|------------------------------------|--|---|
| ◆ Industry focus                   | ◆ Technology and equipment             | ◆ Industrial automation                                 |
| ◆ Theory and research              | ◆ Machinery and mold                   | ◆ Environmental protection and energy saving and safety |
| ◆ Reviews and comprehensive review | ◆ New technologies and new products    | ◆ Enterprise management                                 |
| ◆ Raw materials and formulations   | ◆ Equipment management and maintenance | ◆ Engineering design                                    |
| ◆ Product and design               | ◆ Home and abroad dynamic              | ◆ Patent ◆ Standard                                     |

本刊参加了由中国化工信息中心、中国化工情报信息协会联合主办的“第八届全国石油和化工行业期刊评选活动”，在评比中获优秀期刊一等奖、广告奖和发行奖。

《橡塑技术与装备》是国内外公开发行的国内唯一以橡塑工艺技术、加工机械及新材料新产品为重点内容的专业技术期刊，对外发往东南亚地区及世界橡塑企业、科研机构及相关行业。国内发行遍及30个省、市、自治区的橡塑企业、科研院所、大中专院校及省市级图书馆。半月刊，定价15元/期，国际大16开，广告彩色胶印，装帧精美，是传递信息的桥梁，是介绍企业及其产品的窗口。

This magazine joined excellent publication chosen of National Petroleum and Chemical Industry jointly sponsored by China Chemical Industry Information Center and China Chemical Industry Information Association, and won second prize and award of advertisement.

This magazine is the only one R & P Industry magazine in China which reports for the Industry specially reporting the processing technology and equipment and product, materials issued with English contents and abstract domestically and abroad. This magazine is distributed in R & P enterprises, design and research institute and the some relative areas of South East Asia and the world. And it is also distributed in R & P enterprises, design and research institute, colleges and some libraries of more than 30 provinces and cities in China. This magazine is (semi monthly published) with 15 yuan per issue and international standard A4 edition with new style design and color offset printing. That is the best opening window for introducing your enterprises and products in China.

地址: 北京市海淀区半壁店59号1166室  
Http: www.crpsc.com  
Add: Yuntong Plaza 1166# Banbidian No.59 Haidian  
Http: //www.crpsc.com

邮编: 100143  
E-mail: china-rp@vip.163.com  
Dist: Beijing, China 100143  
E-mail: china-rp@vip.163.com

电话: 010-53100836/38 传真: 010-53100837  
Tel: 0086-010-3100836/38 Fax: 0086-010-53100837



**J I J A M O U L D**<sup>®</sup>  
技佳模具

Professional Pipe fitting Mould Maker  
ISO/TS 16949:2009 certified

**JIECHENG**<sup>®</sup>

**THE BIGGEST MANUFACTURER  
OF PLASTIC FOAM MACHINERY  
IN THE WORLD**

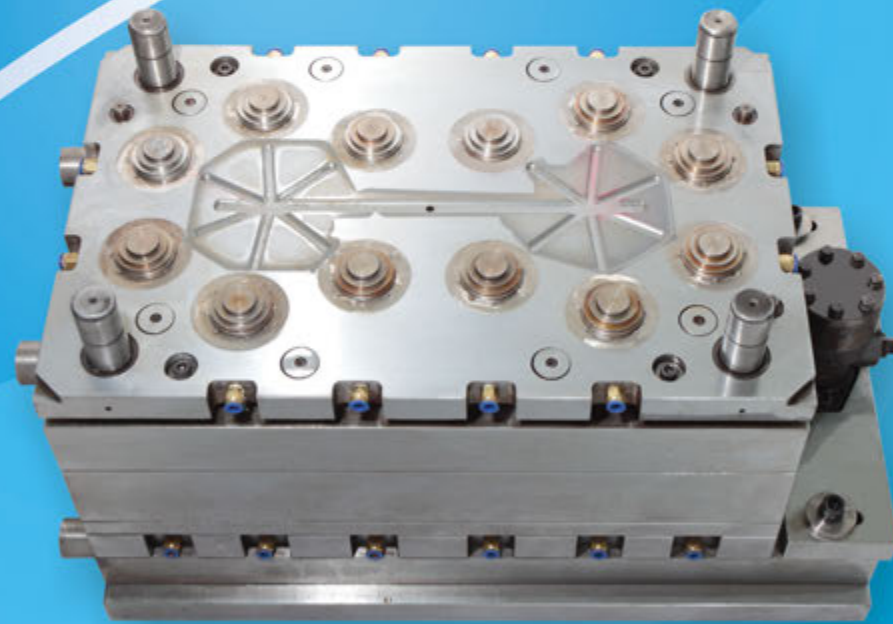
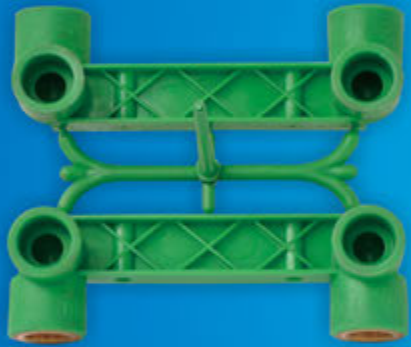

**Booth NO:8bD11-11**

**J I J A M O U L D C O . , L T D .**



Tel: +86-576-84118458 Fax: +86-576-84112871

Mob: +86 13906583721

Http:// www.jijamould.com E-mail:sales@jijamould.com

Address: No.11, Maofeng Street, West Industry Area, Huangyan 318020 Taizhou, Zhejiang, China

**Chongqing Bishan Jiecheng Plastic Co., Ltd**

Http://www.jcfoam.com Http://www.cqjiecheng.com

E-mail: sales@jcfoam.com sales@cqjiecheng.com

Office Line: +86-23-41781538 Mobile: +86-13061613406





# Looking Plas

Service for Plastic Industry

Join  
FREE!



Mobile/Viber/WhatsApp: +86-13518676620

E-mail: [service@lookingplas.com](mailto:service@lookingplas.com)

Whatever you want in Plastic Machinery,  
Moulds & Dies, Raw Materials,  
Contact with LookingPlas,  
We would like to supply solutions.

■ [www.lookingplas.com](http://www.lookingplas.com)



Booth No.:  
8b/G11-05